

**LTECH**

# T Series LED Remote Controller

(This manual applies to: T1/T2/T2M/T3/T3M/T3X)



T1

Dimming  
(8 zones)



T2

Color Temperature



T2M

Color Temperature  
(8 zones)



T3

RGB Sync Control



T3M

RGB Zone Control  
(10 zones)



T3X

RGB Programmable

*Index*

General Information .....	1~5
T1 (Dimming) .....	6~9
T2 (Color Temperature) .....	10~13
T2M (Color Temperature) .....	14~17
T3 (RGB) .....	18~21
T3M (RGB) .....	22~25
T3X (RGB) .....	26~29
After Service .....	30
Reset and Edit the Frequency Point .....	31

**A Notice for the Remote Charging:**

1.  When charging, please connect USB cable.

2. **For T1**



Charging

Completed

For T1, the white indicator light flickers while charging, and turns lasting light means the charging is completed.

**For T2/T2M/T3/T3M/T3X**



Charging

Completed

For T2/T2M/T3/T3M/T3X, the blue indicator light flickers while charging, and turns green means the charging is completed.

The remote can be chargeable even at the OFF state, on which the indicator light is dark.

3. No memory effect in the lithium battery of remote control. Follow the standard charging procedure even for the first three times, no need over charge.
4. Indicator light flickers meaning low battery and need to be charged. (red light for T2/T2M/T3/T3M/T3X, white light for T1)  
Charging in low battery will affect the life of battery.

**For T1**



LED indicator (White) flickers means low battery.

**For T2/T2M/T3/T3M/T3X**



LED indicator (Red) flickers means low battery.

5. The remote should be full charged and stored at a ventilated and dry place when long time no use, and please full recharge every 3 months.

**B Technical Specs:****T1/T2/T2M/T3/T3M/T3X Remote Control**

Charging Voltage:	5Vdc (Built-in Lithium Battery)
Working Current:	<30mA
Working Frequency:	2.4GHz
RF Remote Distance:	30m
Battery Capacity:	1000mAh
Dimensions:	L145×W55×H22(mm)
Package Size:	L168×W96×H34(mm)
Weight (G.W.):	230g

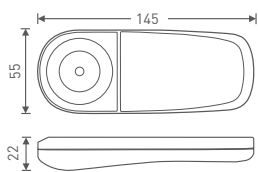
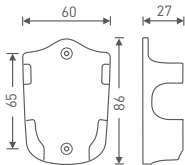
**T1/T2/T2M/T3/T3M/T3X****Remote Holder****T3-CV Receiving Controller**

Compatible Remote:	T1/T2/T2M/T3/T3M/T3X
Input Voltage:	5~24Vdc
Wireless Signal:	2.4GHz
Max Current Load:	6A × 3CH Max 18A
Max Output Power:	90W/216W/432W(5V/12V/24V)
Working Temp.:	-30°C ~ 55°C
Dimensions:	L175×W44×H30(mm)
Package Size:	L178×W48×H33(mm)
Weight (G.W.):	140g

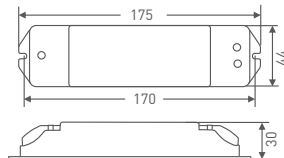
**T3-CV**

### T3-CC Receiving Controller (Current 3 in 1)

Compatible Remote:	T1/T2/T2M/T3/T3M/T3X
Wireless Signal:	2.4GHz
Input Voltage:	12~48Vdc
Output Voltage:	3-46Vdc
Output Current:	CC 350/700/1050mA × 3CH
Output Power:	1.05W~48.3W × 3CH Max 144.9W
Working Temp.:	-30°C ~ 55°C
Dimensions:	L175×W44×H30(mm)
Package Size:	L178×W48×H33(mm)
Weight (G.W.):	150g

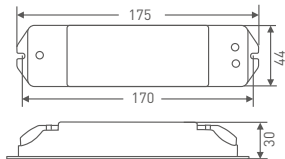

T3-CC

### T3-5A Receiving Controller

Compatible Remote Control:	T3/T3M/T3X
Wireless Signal:	2.4GHz
Input Voltage:	12~24Vdc
Max Current Load:	5A x 3CH Max 15A
Max Output Power:	180W/360W(12V/24V)
Working Temp.:	-30°C ~ 55°C
Dimensions:	L211×W40×H30(mm)
Package Size:	L215×W43×H33(mm)
Weight (G.W.):	165g

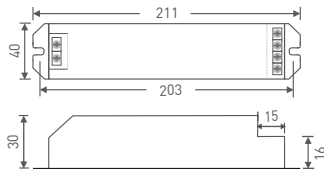

T3-5A

C Terminal of Receivers:

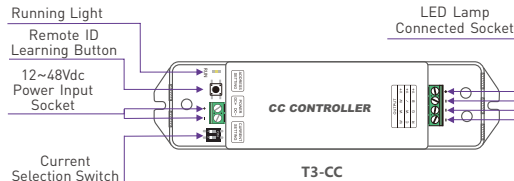
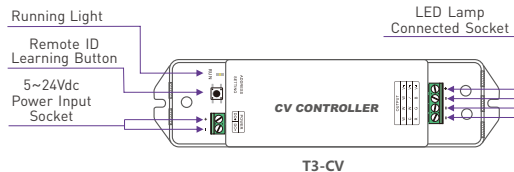

Operation Table

OFF	OFF	OFF	ON	ON	ON
350mA	700mA	1050mA			

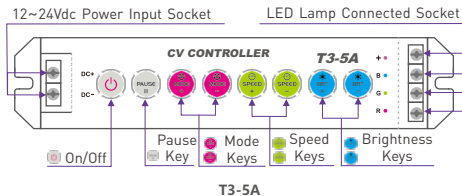

# T1 LED Dimming Controller



T1 remote works with T3-CV, T3-CC receiver.

T1 can realize the signal sync on multiple receivers, zone controlled arbitrarily (no more than 8 zones) within effective distance, a very good solution for the LED project needs sync/zone control wirelessly.

Can RF remote the functions of dimming, quick brightness selection and DIY and so on. User-friendly color wheel for brightness adjustment, unique LED state light for sync change indicated, user can simply know the LED working state from distance by checking the remote control.

## 1. Operation Panel and Component Instruction:

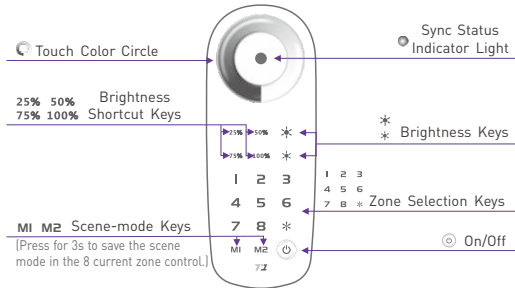



### Zone Control Instruction:

- Select one of the zone: press any key of "1-8" on the remote.
- Select zone control arbitrarily: press "\*" + any number + "\*", eg: take 456 as a zone, should press "\*456\*".
- All choose (8 zones): press "\*" twice.
- When a zone is under inactive state, press the corresponding zone No. to light up that zone.

**Buzzer on/off:** Press "Zone Selection Key" \* for 3 seconds.

## 2. The Learning ID Method of Remote:

### Learning ID:

- A. Turn on the receiver and remote.
- B. Short press "ID learning button"  on the T3-CC/T3-CV receiver, the running light keeps on, then long press any "1-8" "zone-selection key" on the T1 remote, the running light returns to flash (the buzzer long beep, the indicator light  flashes 3 times), activated successful.



If installing multiple receivers in one zone, repeat the above steps, choose the same zone key when ID learning.

### Canceling ID:

- A. Turn on the receiver and remote.
- B. Press "ID learning button"  on the T3-CC/T3-CV receiver more than 8s, the buzzer beep twice, delete all the learned remote.

T1 remote works with T3-CV, T3-CC receiver.



### 3. System Diagram:

Unlimited receivers can be installed in per zone within the effective distance, no wiring needed between the receivers, the installed quantity of LED receivers in per zone can be increased or decreased at any time based on the actual requirements. If you want to increase or decrease the receivers, just activate or cancel the control ID on the remote control will be fine, no any changes and effects on other receivers.

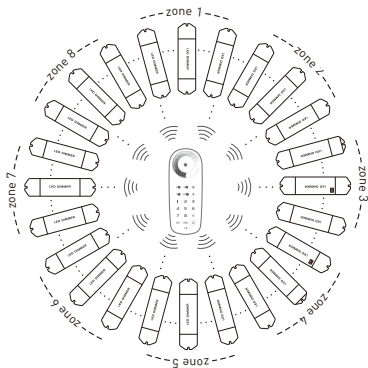

Centralized Zone-division

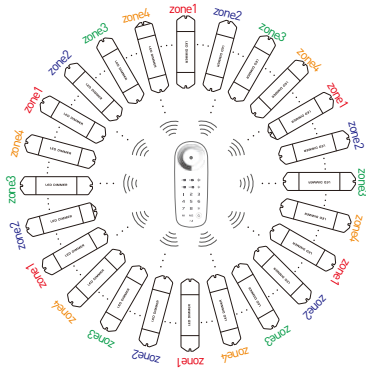

Spacing Zone-division

## 4. Wiring Diagram:

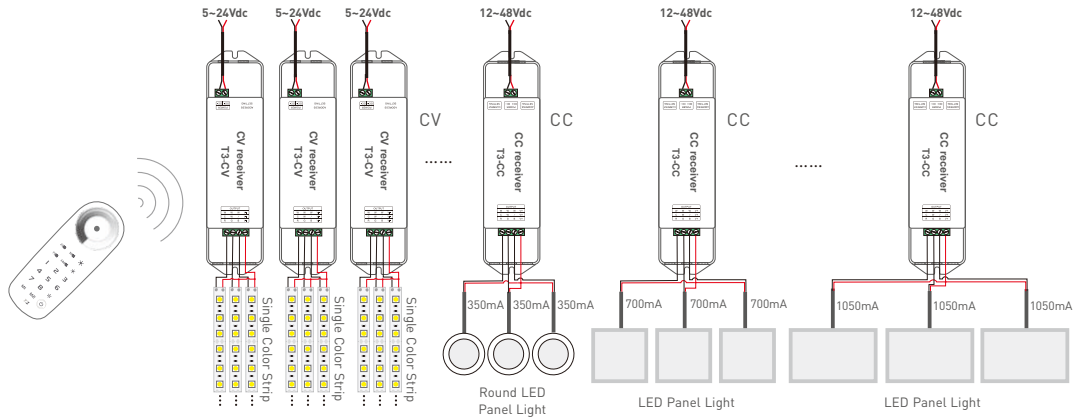

## T2 LED Color Temperature Controller



T2 remote works with T3-CV, T3-CC receiver.

T2 can realize the signal sync on unlimited receivers within effective distance, a very good solution for the LED project needs sync control wirelessly.

Can RF remote the functions of color temperature dimming, quick color temperature/brightness selection, DIY and delay off and so on. User-friendly color wheel for color temperature adjustment, unique LED state light for sync change indicated, user can simply know the LED working state from distance by checking the remote control.

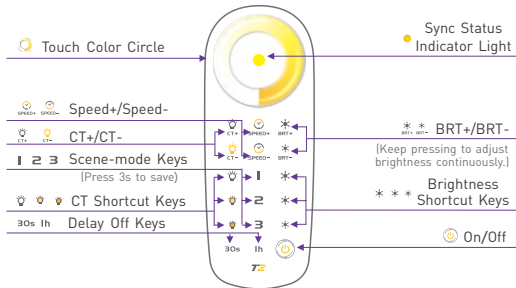

### 1. Operation Panel and Component Instruction:



★Buzzer on/off: Press "Delay Off key" 30s for 3 seconds.

## 2. The Learning ID Method of Remote:

### Learning ID:

1. Turn on the receiver and remote.
2. Short press "ID learning button"  on the T3-CC/T3-CV receiver, the running light keeps on, then long press any key on the T2 remote (except "On/Off" key), the running light returns to flash (the buzzer long beep, the indicator light  flashes 3 times), activated successful.

 If you want to control multiple receivers synchronously, just follow the above instructions for each receiver.

T2 remote works with T3-CV, T3-CC receiver.

### Canceling ID:

1. Turn on the receiver and remote.
2. Press "ID learning button"  on the T3-CC/T3-CV receiver more than 8s, the buzzer beep twice, delete all the learned remote.

### 3. System Diagram:



Unlimited receivers can be installed within effective distance, no wiring needed between the receivers, which can be less or more in quantity according to your need for the installation.

If you want to increase or decrease the receivers, just activate or cancel the control ID on the remote control will be fine, no any changes and effects on the other receivers.

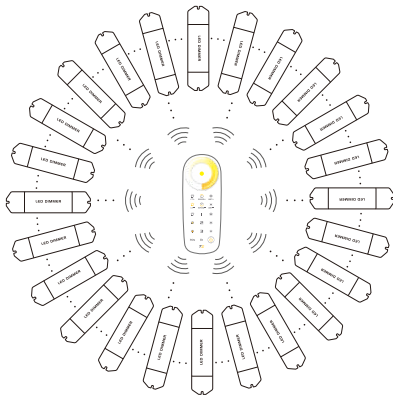

No quantity limit of the receivers.

## 4. Wiring Diagram:

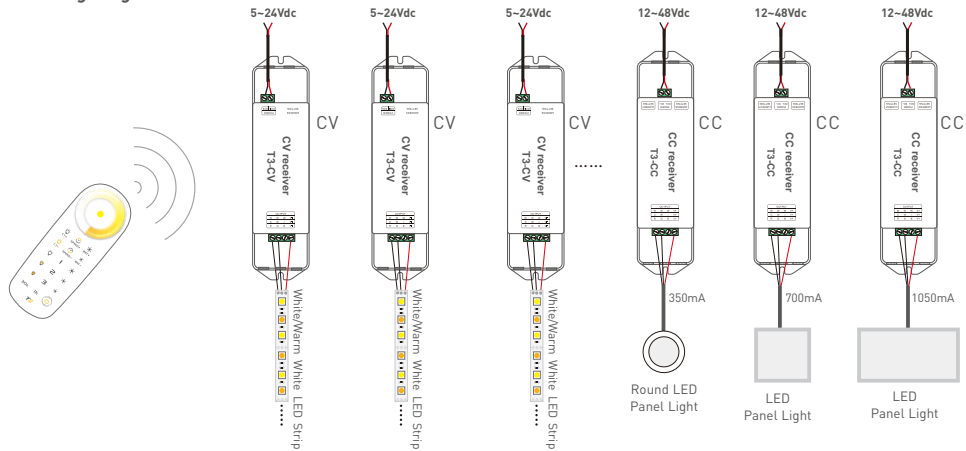

# T2M LED Color Temperature Controller



T2M remote works with T3-CV, T3-CC receiver.

T2M can realize the signal sync on multiple receivers, zone controlled arbitrarily (no more than 8 zones) within effective distance, a very good solution for the LED project needs sync/zone control wirelessly.

Can RF remote the functions of color temperature touch adjustment, brightness adjustment, and DIY scene modes. User-friendly color wheel for color temperature adjustment, unique LED state light for sync change indicated, user can simply know the LED working state from distance by checking the remote control.

## 1. Operation Panel and Component Instruction:

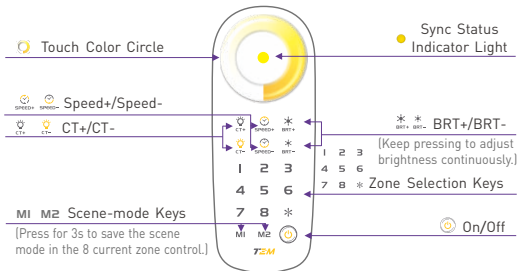



### Zone Control Instruction:

- Select one of the zone: press any key of "1-8" on the remote.
- Select zone control arbitrarily: press "\*" + any number + "\*", eg: take 456 as a zone, should press "\* 456\*".
- All choose(8 zones): press "\*" twice.
- When a zone is under inactive state, press the corresponding zone No. to light up that zone.
- ★ **Buzzer on/off:** Press "Zone Selection Key" \* for 3 seconds.

## 2. The Learning ID Method of Remote:

### Learning ID:

- A. Turn on the receiver and remote.
- B. Short press "ID learning button"  on the T3-CC/T3-CV receiver, the running light keeps on, then long press any "1-8" "zone-selection key" on the T2M remote, the running light returns to flash (the buzzer long beep, the indicator light  flashes 3 times), activated successful.



If installing multiple receivers in one zone, repeat the above steps, choose the same zone key when ID learning.

T2M remote works with T3-CV, T3-CC receiver.

### Canceling ID:

- A. Turn on the receiver and remote.
- B. Press "ID learning button"  on the T3-CC/T3-CV receiver more than 8s, the buzzer beep twice, delete all the learned remote.





### 3. System Diagram:

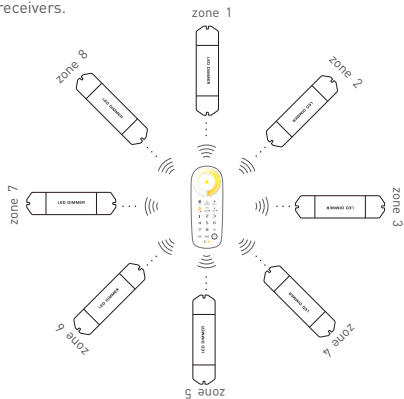

The receivers can be divided into 1~8 zones within effective distance(1pc receiver per zone), no wiring needed between the receivers.



If you don't need color temperature smooth mode by pressing the  **SPEED+**  **SPEED-** each zone can set up unlimited receivers and achieve brightness, color temperature adjustment synchronously.

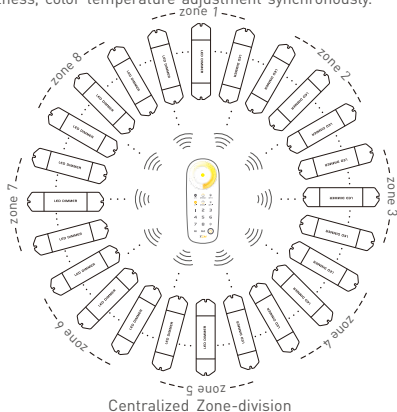

4. Wiring Diagram:

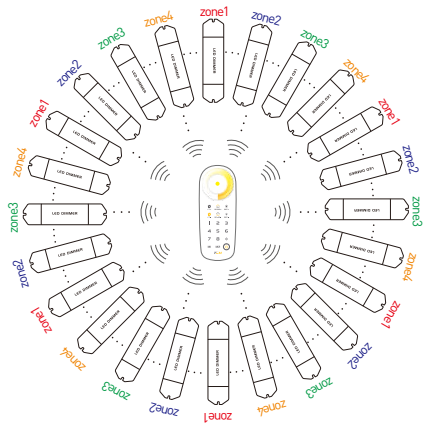

Spacing Zone-division

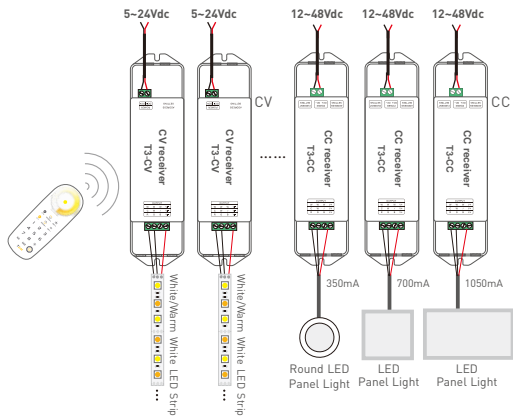

## T3 LED RGB Controller



T3 remote works with T3-CV, T3-CC, T3-5A receiver.

T3 can realize the signal sync on unlimited receivers within effective distance, a very good solution for the LED project needs sync control wirelessly.

Can RF remote the functions of switch, pause, changing modes, changing speed and the brightness and so on. Built-in 32 changing modes, you can save the changing modes in the shortcut key as you like, which not only can call at any time, but also can combine into a program to play in loop.

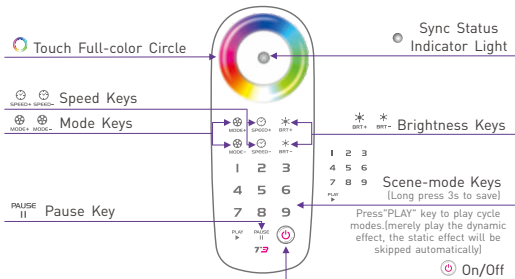

### 1. Operation Panel and Component Instruction:





★ **Buzzer on/off:** Press "Pause key" <sup>PAUSE</sup> <sub>II</sub> for 3 seconds.

## 2. The Learning ID Method of Remote:

### T3-5A Learning ID:



- Turn on the receiver and remote.
- Press "on/off"  on the T3-5A for 2s, there is a buzzer sound, keep press, then press any key on the T3 (except "on/off" key) until the indicator light  flashes 3 times(the buzzer long beep at the same time), learning ID successful, release all the keys.

### T3-5A Cancelling ID:

- Turn on the receiver and remote.
- Press "on/off"  on the T3-5A for 2s, there is a buzzer sound, keep press, after 5s press any keys on the T3 (except "on/off"), until the indicator light  flashes 3 times, release all the keys.

T3 remote works with T3-CV, T3-CC, T3-5A receiver.

### T3-CC/T3-CV Learning ID:

- Turn on the receiver and remote.
- Short press "ID learning button"  on the T3-CC/T3-CV receiver, the running light keeps on, then long press any keys (except "on/off") on the T3, the running light returns to flash (the buzzer long beep, the green light  flashes 3 times), activated successful.

### T3-CC/T3-CV Cancelling ID:

- Turn on the receiver and remote.
- Press "ID learning button"  on the T3-CC/T3-CV receiver more than 8s, the buzzer beep twice, delete all the learned remote.



If you need to control multiple receivers synchronously, follow the above steps for each receiver.

### 3. Tables of Changing Mode:

No.	Mode	No.	Mode
1	Static red	17	Cyan fade out and fade in
2	Static green	18	White fade out and fade in
3	Static blue	19	RGB fade out and fade in
4	Static yellow	20	Red/Green color smooth
5	Static purple	21	Red/Blue color smooth
6	Static cyan	22	Green/Blue color smooth
7	Static white	23	Red/Yellow color smooth
8	RGB jumping	24	Green/Cyan color smooth
9	7 colors jumping	25	Blue/Purple color smooth
10	White strobe	26	Green/Yellow color smooth
11	7 colors strobe	27	Blue/Cyan color smooth
12	Red fade out and fade in	28	Red/Purple color smooth
13	Green fade out and fade in	29	Blue/White color smooth
14	Blue Fade out and fade in	30	Yellow/Purple/Cyan color smooth
15	Yellow fade out and fade in	31	RGB color smooth
16	Purple fade out and fade in	32	Full-color smooth

**Comment:** Speed/Brightness adjustable.

### 4. System Diagram:

 Unlimited receivers can be installed within effective distance, no wiring needed between the receivers, if you want to increase or decrease the receivers, just activate or cancel the control ID will be fine, no any changes and effects on other receivers.

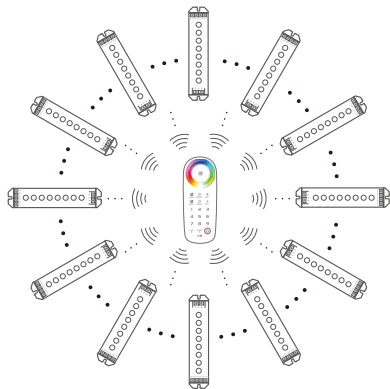

5. Wiring Diagram:

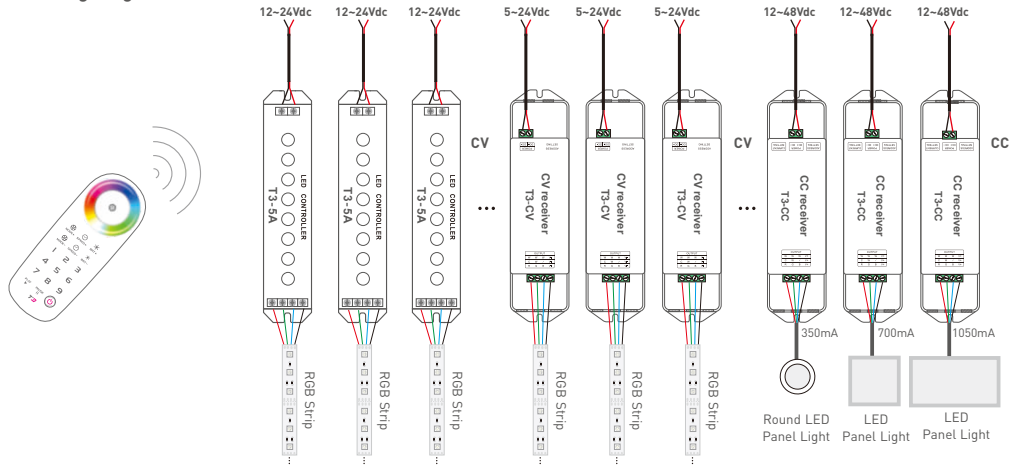

# T3M LED RGB Controller



T3M remote works with T3-CV, T3-CC, T3-5A receiver.

T3M can realize the signal sync on multiple receivers, zone controlled arbitrarily (no more than 10 zones) within effective distance, a very good solution for the LED project needs sync control wirelessly.

Can RF remote the functions of switch, pause, changing modes, changing speed and the brightness and so on. Satisfied with your requirement of sync control multiple zones, group control or control separately, which it is easy to use.

## 1. Operation Panel and Component Instruction:

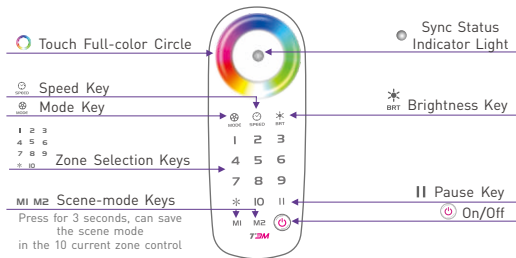



### Zone Control Instruction:

- Select one of the zone: press any key of "1-10" on the remote.
- Select zone control arbitrarily: press "\*" + any number + "\*", eg: take 456 as a zone, should press "\*456\*".
- All choose(10 zones): press "\*" twice.



★**Buzzer on/off:** Press "Pause key" || for 3 seconds.

## 2. The Learning ID Method of Remote:



### T3-5A Learning ID:

- Turn on the receiver and remote.
- Press "on/off"  on the T3-5A for 2s, there is a buzzer sound, keep press, then press any key of "1-10" zone on the T3M until the indicator light  of remote flashes 3 times (the buzzer long beep at the same time), learning ID successful, release all the keys.

### T3-5A Cancelling ID:

- Turn on the receiver and remote.
- Press "on/off"  on the T3-5A for 2s, there is a buzzer sound, keep press, after 5s press any key of "1-10" zone on the T3M, until the indicator light  of remote flashes 3 times, release all the keys.

### T3-CC/T3-CV Learning ID:

- Turn on the receiver and remote.
- Short press "ID learning button"  on the T3-CC/T3-CV receiver, the running light keeps on, then long press any key of "1-10" zone on the T3M remote, the running light returns to flash (the buzzer long beep, the green light  flashes 3 times), activated successful.

### T3-CC/T3-CV Cancelling ID:

- Turn on the receiver and remote.
- Press "ID learning button"  on the T3-CC/T3-CV receiver more than 8s, the buzzer beep twice, delete all the learned remote.

T3M remote works with T3-CV, T3-CC, T3-5A receiver.



### 3. Tables of Changing Mode:

No.	Mode	No.	Mode
1	3 colors jumping	10	Green/Cyan color smooth
2	7 colors jumping	11	Blue/Purple color smooth
3	White strobe	12	Green/Yellow color smooth
4	7 colors strobe	13	Blue/Cyan color smooth
5	RGB fade out and fade in	14	Red/Purple color smooth
6	Red/Green color smooth	15	Blue/White color smooth
7	Red/Blue color smooth	16	Yellow/Purple/Cyan color smooth
8	Green/Blue color smooth	17	RGB color smooth
9	Red/Yellow color smooth	18	Full-color smooth

**Comment:** Speed/Brightness adjustable.

### 4. System Diagram:



The receivers can be divided into 1–10 zones within effective distance(1pc receiver per zone), no wiring needed between the receivers.

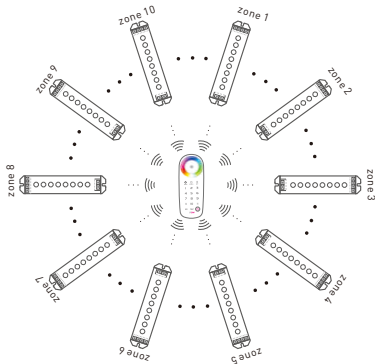

### 5. Wiring Diagram:

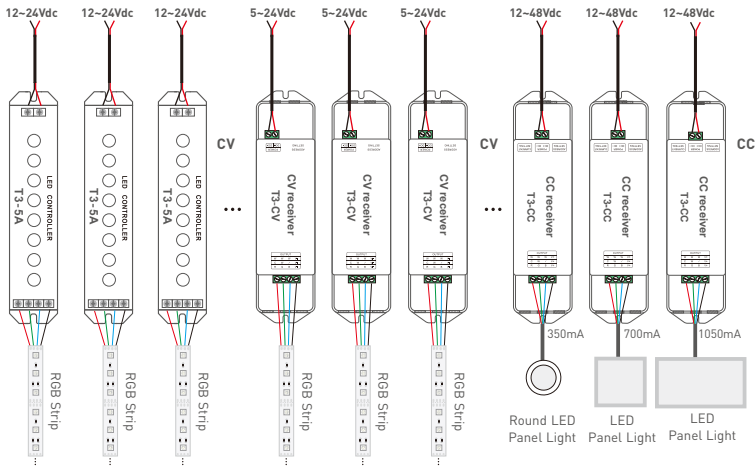

# T3X

## LED RGB Programmable Controller



T3X remote works with T3-CV, T3-CC, T3-5A receiver.

T3X can realize the signal sync on unlimited receivers within effective distance, a very good solution for the LED project needs sync control wirelessly.

Can RF remote the functions of switch, pause, mode, speed and LED brightness. More proudly, the T3X has the brand-new programmable function, only 10 seconds to DIY a new change effect.

Programming has never been so easy.

### 1. Operation Panel and Component Instruction:

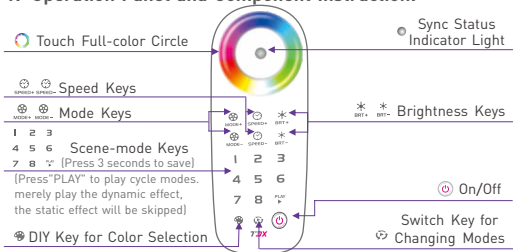



#### DIY Key for Color Selection



- Long press for 2 seconds to enter DIY programming function.
    1. Select any color on the controller will save immediately.
    2. Press to enter next color. (can save 1-10 colors)
    3. After color selection, press to switch jumping/smooth/flickering changing effect.
    4. Adjust the brightness and the speed by pressing the "SPEED" and "BRT".
    5. Save the new program into the "Scene-mode keys".
  - Additional Functions:
    - ▲ Long press "DIY key for color selection" to clear the current color.
    - ▲ Press "MODE" key under DIY function, can display the standard color for black, red, green, blue, yellow, purple, cyan and white. Among them, black can be used for editing fade in dimming effect, etc.
- ★ **Buzzer on/off:** Press "Scene-mode Key" for 3 seconds.

## 2. The Learning ID Method of Remote:

### T3-5A Learning ID:



- A. Turn on the receiver and remote.
- B. Press "On/Off"  on the T3-5A for 2s, there is a buzzer sound, keep press, then press any key on the T3X (except "On/Off" key) until the indicator light  flashes 3 times(the buzzer long beep at the same time), learning ID successful, release all the keys.

### T3-5A Cancelling ID:

- A. Turn on the receiver and remote.
- B. Press "On/Off"  on the T3-5A for 2s, there is a buzzer sound, keep press, after 5s press any key on the T3X (except "On/Off"), until the indicator light  flashes 3 times, release all the keys.

T3X remote works with T3-CV, T3-CC, T3-5A receiver.

### T3-CC/T3-CV Learning ID:

- A. Turn on the receiver and remote.
- B. Short press "ID learning button"  on the T3-CC/T3-CV receiver, the running light keeps on, then long press any key (except "On/Off") on the T3X remote, the running light returns to flash (the buzzer long beep, the green light  flashes 3 times), activated successful.

### T3-CC/T3-CV Cancelling ID:

- A. Turn on the receiver and remote.
- B. Press "ID learning button"  on the T3-CC/T3-CV receiver more than 8s, the buzzer beep twice, delete all the learned remote.



If you need to control multiple receivers synchronously, follow the above steps for each receiver.

### 3. Tables of Changing Mode:

No.	Mode	No.	Mode
1	Static red	17	Cyan fade out and fade in
2	Static green	18	White fade out and fade in
3	Static blue	19	RGB fade out and fade in
4	Static yellow	20	Red/Green color smooth
5	Static purple	21	Red/Blue color smooth
6	Static cyan	22	Green/Blue color smooth
7	Static white	23	Red/Yellow color smooth
8	RGB jumping	24	Green/Cyan color smooth
9	7 colors jumping	25	Blue/Purple color smooth
10	White strobe	26	Green/Yellow color smooth
11	7 colors strobe	27	Blue/Cyan color smooth
12	Red fade out and fade in	28	Red/Purple color smooth
13	Green fade out and fade in	29	Blue/White color smooth
14	Blue fade out and fade in	30	Yellow/Purple/Cyan color smooth
15	Yellow fade out and fade in	31	RGB color smooth
16	Purple fade out and fade in	32	Full-color smooth

**Comment:** Speed/Brightness adjustable.

### 4. System Diagram:



Unlimited receivers can be installed within effective distance, no wiring needed between the receivers, if you want to increase or decrease the receivers, just activate or cancel the control ID will be fine, no any changes and effects on other receivers.

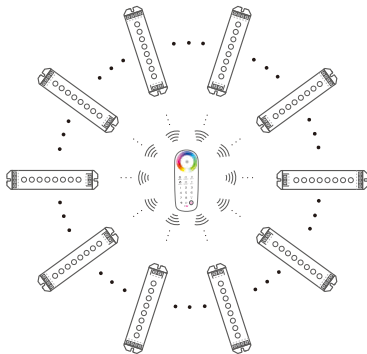

5. Wiring Diagram:

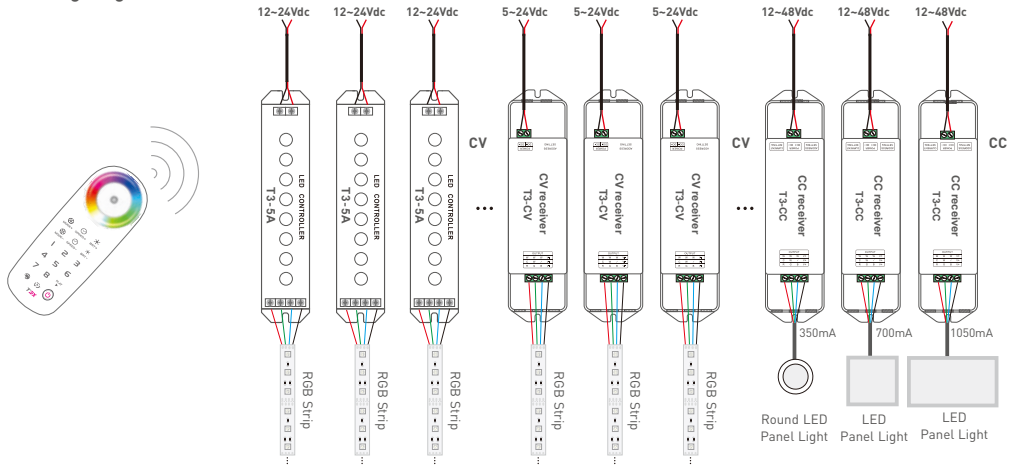

## I . Attention:

- A. The product shall be installed and serviced by the qualified person.
- B. This product is non-waterproof. Please avoid the sun and rain. When installed outdoors please ensure it is mounted in a water proof enclosure.
- C. Good heat dissipation will prolong the working life of the controller. Please ensure good ventilation.
- D. Please check if the output voltage of the LED power supply used comply with the working voltage of the product.
- E. Please ensure that adequate sized cable is used from the controller to the LED lights to carry the current. Please also ensure that the cable is secured tightly in the connector.
- F. Ensure all wire connections and polarities are correct before applying power to avoid any damages to the LED lights.
- G. If a fault occurs, please return the product to your supplier. Do not attempt to fix this product by yourself.



## II. Warranty Agreement:

- A. We provide lifelong technical assistance with this product:
  - A 5-year warranty is given from the date of purchase. The warranty is for free repair or replacement if cover manufacturing faults only.
  - For faults beyond the 5-year warranty, we reserve the right to charge for time and parts.
- B. Warranty exclusions below:
  - Any man-made damages caused from improper operation, or connecting to excess voltage and overloading.
  - The product appears to have excessive physical damage.
  - Damage due to natural disasters and force majeure.
  - Warranty label, fragile label and unique barcode label have been damaged.
  - The product has been replaced by a brand new product.
- C. Repair or replacement as provided under this warranty is the exclusive remedy to the customer. We shall not be liable for any incidental or consequential damages for breach of any stipulation in this warranty.
- D. Any amendment or adjustment to this warranty must be approved in writing by our company only.
  - ★ This manual only applies to this model. We reserve the right to make changes without prior notice.

## Reset and Edit the Frequency Point

### A. Reset Function:

**Feature:** Reset function is available when remote operates abnormally.

**Operation:** Long press the 2 keys on the positions of   simultaneously, release after 3 seconds, the remote will be auto off, means reset completed. and then could restart the remote.

### B. Check and Edit the Frequency Point on the Remote:

**Feature:** a. Revising the frequency point to eliminate the external disturbance. 12 revisable frequency points for user.





b. Multiple remotes sync-control becomes available when they use the same frequency point.

**Attn:** After reset or revised the frequency points in the remote, receivers only can be used after relearn the ID.









Remotes of the same frequency point, only one remote could be used to execute the learning ID process, the rest needs to be off.





#### Check the Frequency Point on the Remote:

Turn on the remote, long press the key  for 5 seconds until the red light  (white light  for T1) flashes 3 times, and then the green light  (white light for T1  ) flashes, the numbers of the flash will be the frequency point of the remote. you can only edit the frequency point after 3 seconds.

**Edit the Frequency Point on the Remote:** In frequency changing state,

Method 1: Short press any key on the positions of     
    
  , the frequency point will be "1-9" correspondingly, the light will flash in the same numbers. Then press any key or touch the color circle to exit the frequency edit state.

Method 2: Long press "on/off" key  over 5 seconds, the green light  (white light  for T1) flashes, the flash times plus 1 means the frequency point accumulate 1. In short, long press the "on/off" key  over 5 seconds each time, the frequency point will accumulate 1, which will again become value 1 when added to 12, and that cycle repeats.



# T Series LED Remote Controller

## Applied Range

- Architectural ornament: business area, airport, subway station.
- Interior decoration: hotel, shopping mall, square, restaurant, pub, home furnishing, etc.
- Signboard, billboard.
- Anywhere else, where uses LED for dimming, color temperature and full color adjustment.



## Parameters

- Charging Voltage: 5Vdc (Built-in Lithium Battery)
- Working Current:  $\leq 30\text{mA}$
- Working Frequency: 2.4GHz
- Remote Distance: 30m
- With USB Charging Port



[www.ltech-led.com](http://www.ltech-led.com)

FC CE RoHS [warranty 5 years]

