

LED Intelligent Driver (constant voltage)

- Small size and light weight. The housing is made from V0 flame retardant PC materials that SAMSUNG/COVESTRO uses.
- The clamshell design and screwless type for strain-relief. The design of dismountable end cap allows you to adjust the length of housing depending on your needs.
- Dimming interface: DMX512/RDM, Push DIM.
- Dimming range from 0-100%, LED start at 0.1% possible.
- With soft-on and fade in function, visual more comfortable.
- Supports RDM remote device management protocol.
- High efficient driver: efficiency 93%, PF>0.98, THD<6%.
- In line with the EU energy efficiency ERP directive, standby power consumption < 0.5W.
- Innovative thermal management technology, intelligent power life protection.
- Over-heat / Over voltage / Over load / Short circuit protection, recover automatically.
- Fully-protected plastic housing with design of dismountable end cover.
- Suitable for internal lights application for I / II / III.
- Up to 50,000-hour life time.
- 5 years warranty (Rubycon capacitor).



Flicker Free
IEEE 1789

Dimmable:
0.1%-100%

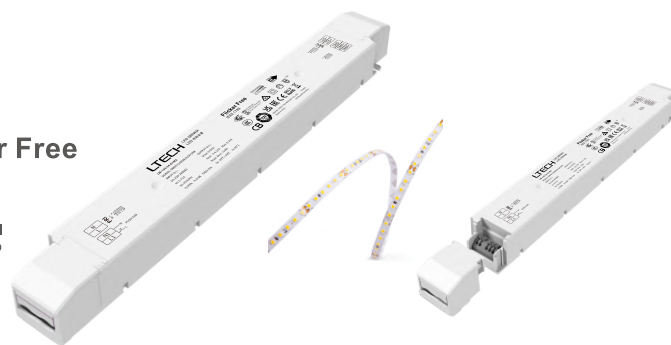

Technical Specs

Model	LM-150-24-G1M2	LM-150-12-G1M2		
OUTPUT	Output Voltage	24Vdc	12Vdc	
	Output Voltage Range	24Vdc ± 0.5Vdc	12Vdc ± 0.5Vdc	
	Output Current	Max. 6.25A	Max. 12.5A	
	Output Power	Max. 150W		
	Output Power Range	0-150W		
	Strobe Level	High frequency exemption level		
	Dimming Range	0-100%, down to 0.1%		
	Overload Power Limitation	≥102%		
	Ripple	Switch ripple≤200mV, noise≤500mV	Switch ripple≤200mV, noise≤800mV	
PWM frequency	3600Hz			
INPUT	Dimming Interface	DMX/RDM, Push DIM		
	Input Voltage	220-240Vac 200-280Vdc		
	Frequency	50/60Hz		
	Input Current	≤0.75A/230Vac		
	Power Factor	PF>0.98/230Vac [at full load]		
	THD	THD<6%@230Vac [at full load]		
	Efficiency (typ.)	93%	92%	
	Standby Power Loss	0.5W		
	Inrush Current	Cold start 45A/230Vac		
Anti Surge	L-N: 2KV			
Leakage Current	Max. 0.5mA			
ENVIRONMENT	Working Temperature	ta: -20 ~ 50°C tc: 85°C		
	Working Humidity	20 ~ 95%RH, non-condensing		
	Storage Temperature, Humidity	-40 ~ 80°C, 10-95%RH		
	Temperature Coefficient	±0.03%/°C [0-50°C]		
Vibration	10-500Hz, 2G 12min/1cycle, 72 min for X, Y and Z axes respectively			
PROTECTION	Overheat Protection	Intelligently adjust or turn off the output current if the PCB temperature ≥110°C, and recover automatically		
	Overload Protection	Shut down the output when current load≥102%, and recover automatically		
	Short Circuit Protection	Enter hiccup mode if short circuit occurs, and recover automatically		
	Overvoltage Protection	Shut down the output when non-load voltage≥28V, and recover automatically	Shut down the output when non-load voltage≥16V, and recover automatically	
SAFETY & EMC	Withstand Voltage	I/P-O/P: 3750Vac		
	Isolation Resistance	I/P-O/P: 100MQ/500VDC/25°C/70%RH		
	Safety Standards	CCC	China	GB19510.1, GB19510.14
		TUV	Germany	EN61347-1, EN61347-2-13, EN62493
		CB	CB member states	IEC61347-1, IEC61347-2-13
		CE	European Union	EN61347-1, EN61347-2-13, EN62384, EN61547
		KC	Korea	KC61347-1, KC61347-2-13
		EAC	Russia	IEC61347-1, IEC61347-2-13
		RCM	Australia	AS 61347-1, AS 61347-2-13
		EMEC	Europe	EN61347-1, EN61347-2-13, EN62384
	UKCA	Britain	BS EN 61347-2-13:2014+A1:2017, BS EN 61347-1:2015+A1:2021	
	EMC Emission	CCC	China	GB/T17743, GB17625.1
		CE	European Union	EN55015, EN61000-3-2, EN61000-3-3, EN61547
		KC	Korea	KN15, KN61547
EAC		Russia	IEC62493, IEC61547, EH55015	
RCM		Australia	EN55015, EN61000-3-2, EN61000-3-3, EN61547	
UKCA		Britain	BS EN IEC 55015:2019/A1:2020, BS EN 61547:2009, BS EN IEC 61000-3-2:2019, BS EN 61000-3-3:2013/A1:2019	
EMC Immunity	EN61000-4-2,3,4,5,6,8,11, EN61547			
Strobe Test Standard	IEEE 1789			
OTHERS	Gross weight[G.W]	430g±10g		
	Dimensions	352×43×30mm[L×W×H]		
	Package size	355×44×33mm[L×W×H]		
	Carton Size	370×340×93mm[L×W×H] 20pcs/ctn 9.4kg±5%/ctn		

The driver is suitable for connecting resistor current-limiting LED fixture (e.g. LED strip). The inrush current will be dozens of times increased if connecting built-in constant current IC current-limiting LED fixtures, the driver will activate the overloaded protection (hiccup flickering). When you order, please remark controlling the constant current LED fixture (e.g. MR16 lamp, underground light, LED wall washer, constant current LED strip, etc.), so that we can prepare them with special procedures.

Dimensions

Unit: mm

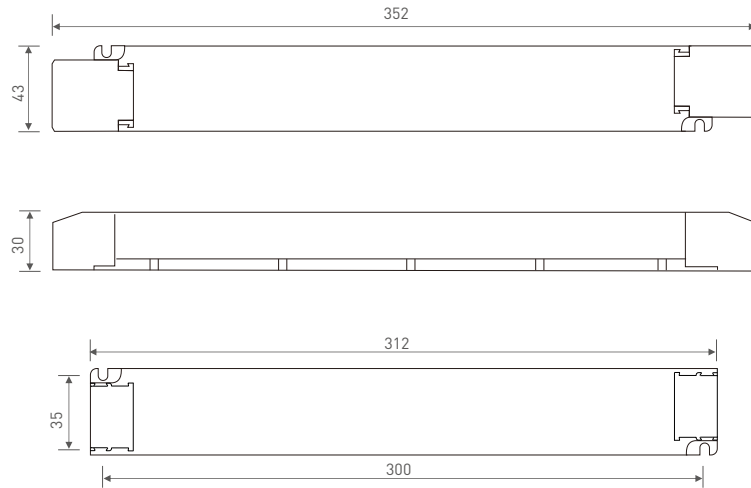

Wiring Diagram

DMX/RDM Connection

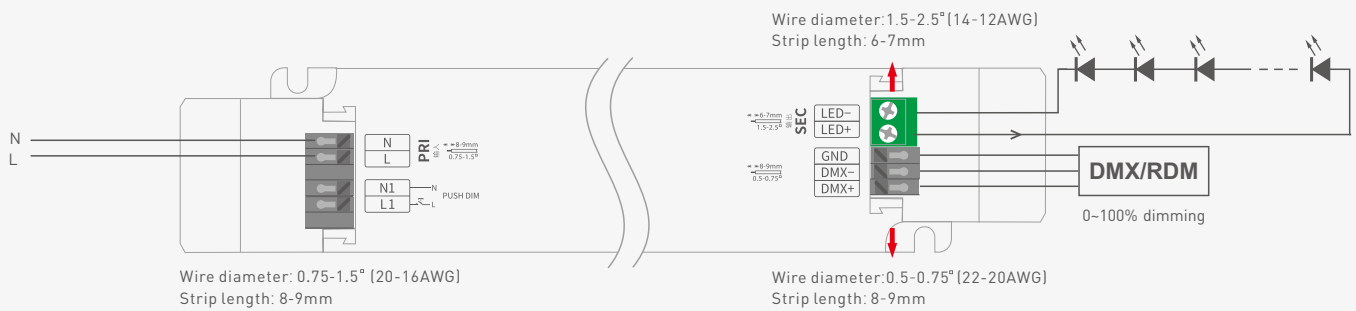

Push DIM Connection

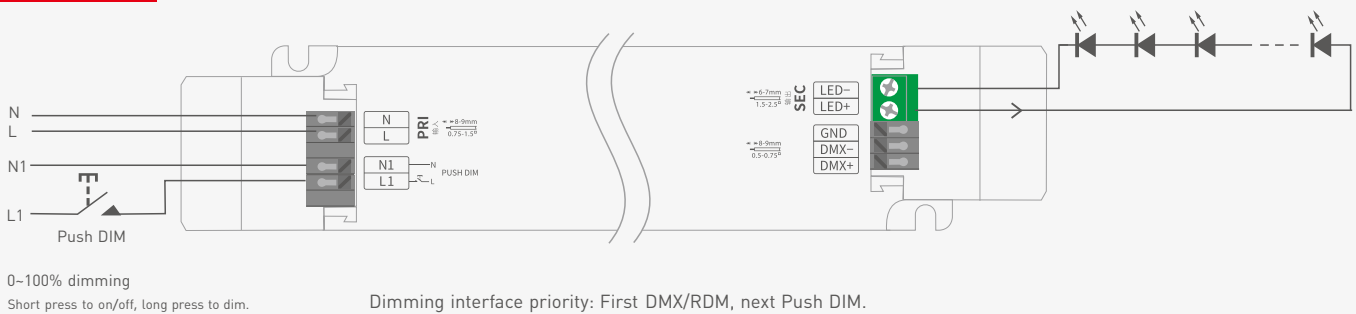

Push DIM



Reset switch

- On/off control: Short press.
- Stepless dimming: Long press.
- With every other long press, the brightness goes to the opposite direction.
- Dimming memory: Brightness will be the same as previously adjusted when turning on again.

Application of Protective Cover

Wire pressing board:

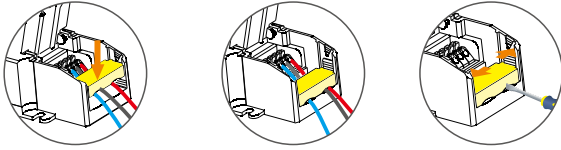

Push the wire pressing board to fix the wires.

Push outward the side plate, meanwhile use the tool to uninstall the wire pressing board.

Uninstall protective cover:

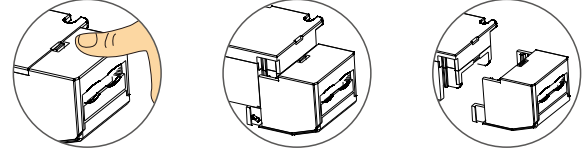

Break off the bottom left and right to remove the protective cover.

Installation Precautions

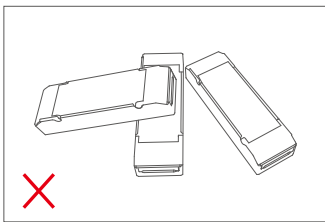

Please do not stack the products. The distance between two products should be $\geq 15\text{cm}$ so as not to affect heat dissipation and the lifespan of the products.

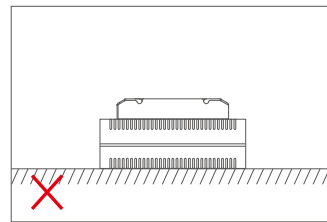
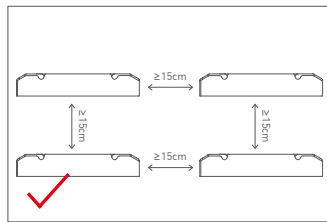

Please not place the products on LED drivers. The distance between the product and the driver should be $\geq 15\text{cm}$ so as not to affect heat dissipation and shorten the lifespan of the products.

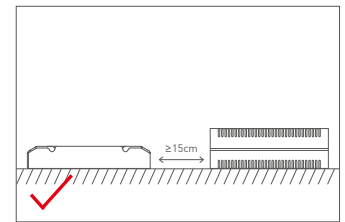

DMX Address Setting

The DMX driver can work with the address editor that complies with standard RDM protocol.

It is recommended to use LTECH's RDM editor (model WiFi-RDM01), which can achieve more functions such as remote browsing and parameter setting. Wiring diagram as below:

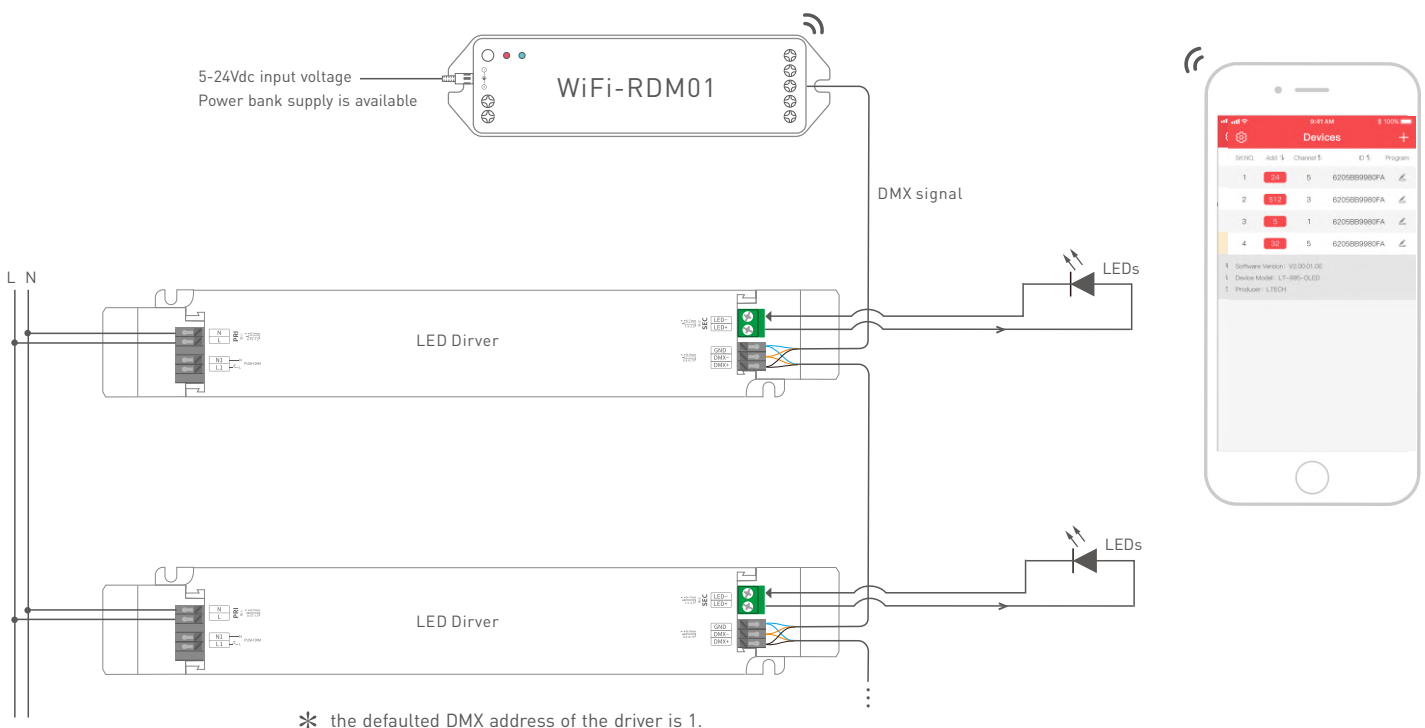

LTECH RDM editor App interface instruction

Download the App, setting the parameters after well connecting the RDM editor, please check the manual of WiFi-RDM01 for more details.

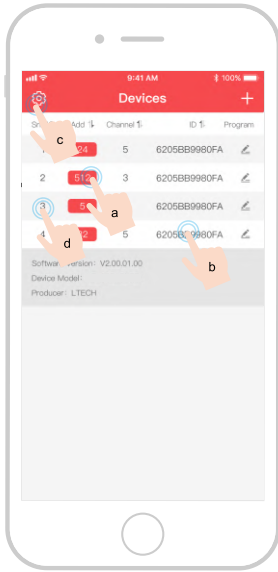

- a: Click "Add", edited the address in corresponding box.
- b: Click "ID", get more product details.
- c: Click "Settings", enter setting interface.
- d: Click "No.", issue the recognizing command.

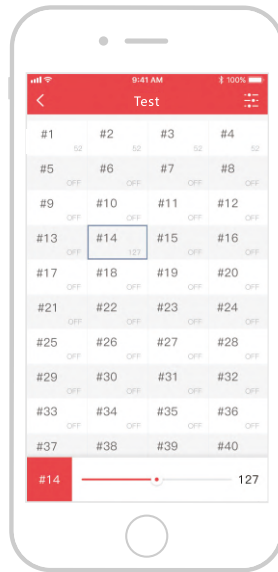

Test

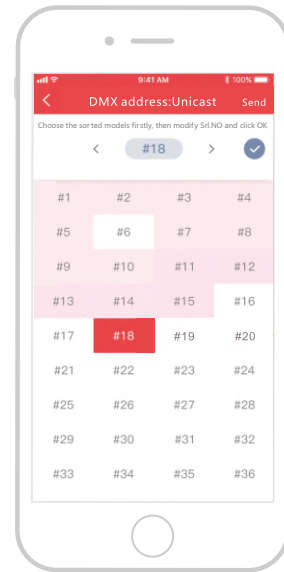

DMX address setting

Relationship Diagrams

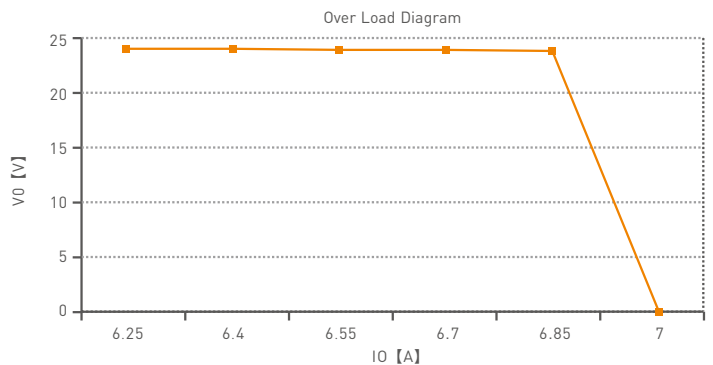
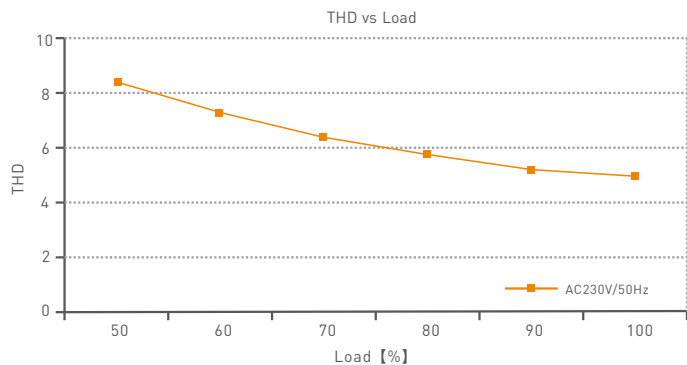
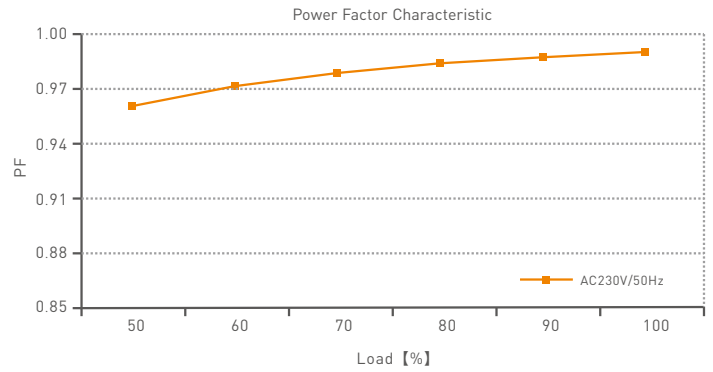
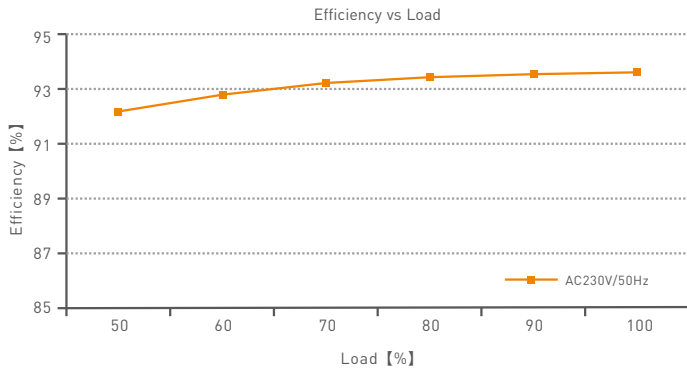

LM-150-24-G1M2

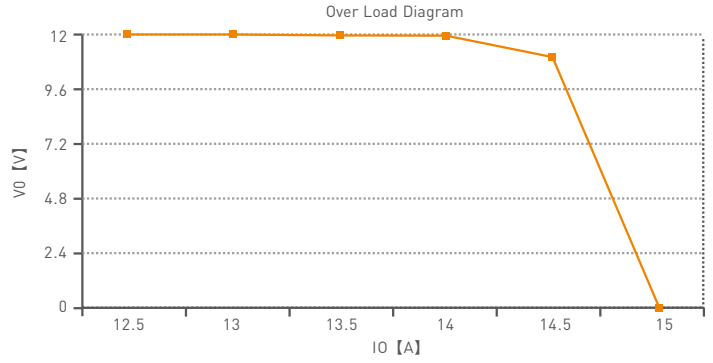
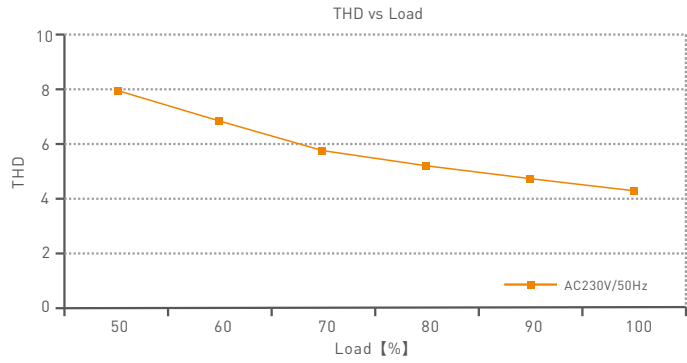
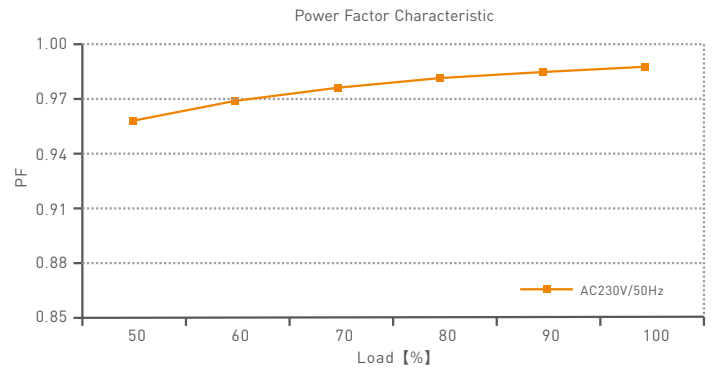
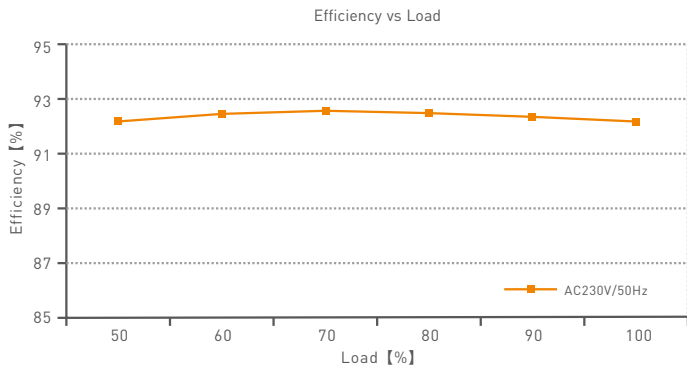

LM-150-12-G1M2

Flicker Test Form

IEEE 1789

Limit of Modulation in low risk area	
Waveform frequency of Optical output	limit (%)
$f \leq 8\text{Hz}$	0.2
$8\text{Hz} < f \leq 90\text{Hz}$	$0.025 \times f$
$90\text{Hz} < f \leq 1250\text{Hz}$	$0.08 \times f$
$f > 1250\text{Hz}$	Exemption assessment
Limit of Modulation in no effect area	
Waveform frequency of Optical output	limit (%)
$f \leq 10\text{Hz}$	0.1
$10\text{Hz} < f \leq 90\text{Hz}$	$0.01 \times f$
$90\text{Hz} < f \leq 3125\text{Hz}$	$(0.08/2.5) \times f$
$f > 3125\text{Hz}$	Exemption assessment (High frequency exemption)

Brightness

- ▲ 0.1 %
- ◆ 1 %
- ▲ 5 %
- ◆ 10 %
- 20 %
- ▲ 30 %
- 40 %
- ★ 50 %
- 60 %
- 70 %
- ◆ 80 %
- ★ 90 %
- ◆ 100 %

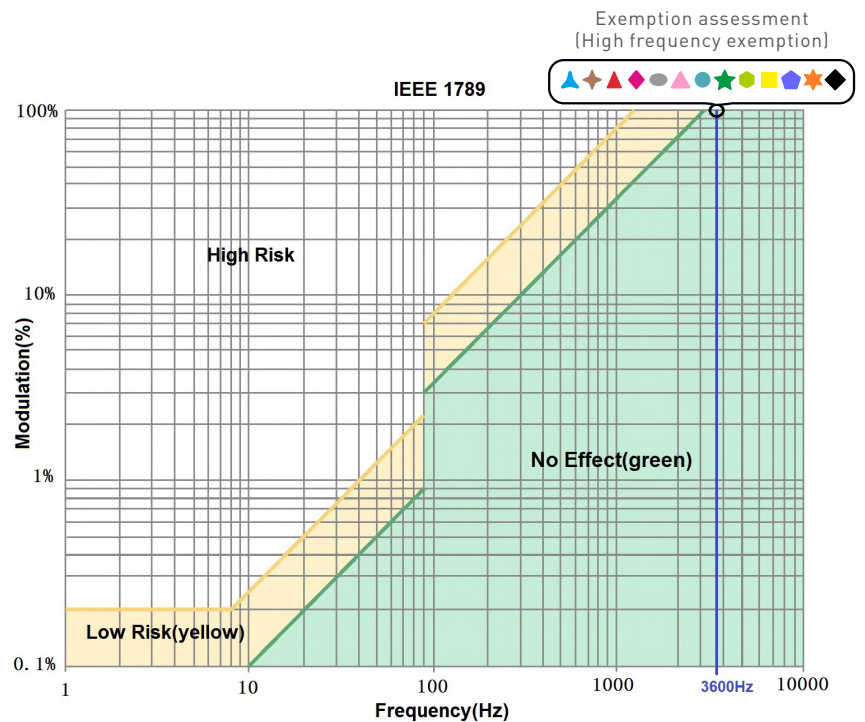

Attentions

- Products shall be installed by qualified professionals.
 - LTECH products are non-waterproof (special models excepted). Please avoid the sun and rain. When installed outdoors, please ensure it is mounted in a water proof enclosure.
 - Good heat dissipation will extend the working life of products. Please ensure good ventilation.
 - Please check if the working voltage used complies with the parameter requirements of products.
 - The diameter of wire used must be able to load the light fixtures you connect and ensure the firm wiring.
 - Before you power on products, please make sure all the wiring is correct in case of incorrect connection that causes damage to light fixtures.
 - If a fault occurs, please do not attempt to fix products by yourself. If you have any question, please contact your suppliers.
- * This manual is subject to changes without further notice. Product functions depend on the goods. Please feel free to contact our official distributors if you have any question.

Warranty Agreement

- Warranty periods from the date of delivery: 5 years.
- Free repair or replacement services for quality problems are provided within warranty periods.

Warranty exclusions below:

- Beyond warranty periods.
- Any artificial damage caused by high voltage, overload, or improper operations.
- Products with severe physical damage.
- Damage caused by natural disasters and force majeure.
- Warranty labels and barcodes have been damaged.
- No any contract signed by LTECH.

1. Repair or replacement provided is the only remedy for customers. LTECH is not liable for any incidental or consequential damage unless it is within the law.
2. LTECH has the right to amend or adjust the terms of this warranty, and release in written form shall prevail.

Update Log

Version	Updated Time	Update Content	Updated by
A0	2020.03.24	Original version	Huang Yunting
A1	2020.05.13	Update the relationship chart; increase the rated life of 50000 hours	Huang Yunting
A2	2021.12.10	Update product description; update TUV certification icon	Liu Weili

LED智能调光驱动器 (恒压型)

- 体积小、重量轻; 外壳采用料思创/三星PC阻燃V0级原料
- 免螺丝压线翻盖设计, 可拆卸端盖, 按需调节壳体长度
- 调光接口: DMX512/RDM、Push DIM
- 调光范围0~100%, LED从0.1%开始调光
- 带软启动渐亮功能, 让人眼视觉更舒适
- 支持RDM远程设备管理协议
- 高效能电源: 效率93%、PF>0.98、THD<6%
- 符合欧盟能效ERP指令, 待机功耗<0.5W
- 创新的热管理技术, 智能保护电源寿命
- 过温、过压、过载、短路保护, 可自动恢复
- 全防护塑料外壳电源, 可拆卸端盖设计
- 适合室内 I、II、III类灯具应用
- 高达50,000小时的额定寿命
- 5年保修期 (采用红宝石电容)



无频闪
IEEE 1789
高频豁免考核级别

Dimmable:
0.1%-100%

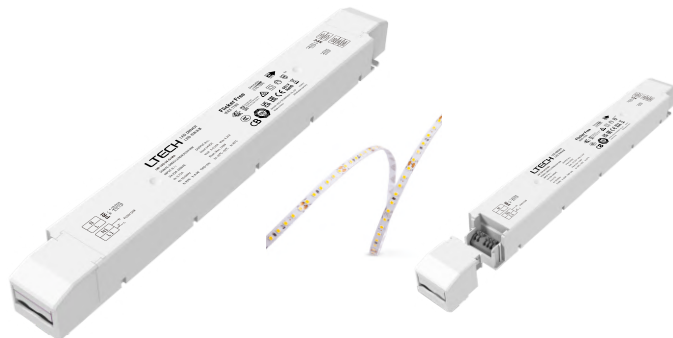

技术参数

型号	LM-150-24-G1M2	LM-150-12-G1M2		
输出	输出电压	24Vdc	12Vdc	
	输出电压范围	24Vdc ± 0.5Vdc	12Vdc ± 0.5Vdc	
	输出电流	Max. 6.25A	Max. 12.5A	
	输出功率	Max. 150W		
	输出功率范围	0~150W		
	频闪级别	高频豁免考核级别		
	调光范围	0~100%, 调光深度: 0.1%		
	过功率限制	≥102%		
	纹波与噪声	开关纹波≤200mV, 噪声≤500mV	开关纹波≤200mV, 噪声≤800mV	
PWM调光频率	3600Hz			
输入	调光接口	DMX/RDM, Push DIM		
	输入电压	220-240Vac 200-280Vdc		
	频率范围	50/60Hz		
	输入电流	Max. 0.75A/230Vac		
	功率因数	PF>0.98/230Vac (满载)		
	谐波THD	230Vac@THD<6% (满载)		
	效率(Typ.)	93%	92%	
	待机功耗	0.5W		
	浪涌电流	冷启动45A/230Vac		
	抗浪涌	L-N: 2KV		
漏电流	Max. 0.5mA			
环境	工作温度	ta: -20 ~ 50°C tc: 85°C		
	工作湿度	20 ~ 95%RH, 无冷凝		
	储存温度/湿度	-40 ~ 80°C, 10~95%RH		
	温度系数	±0.03%/°C(0-50°C)		
	耐振动	10-500HZ, 2G 12分钟/周期, X, Y, Z轴各72分钟		
保护	过温保护	根据PCB温度超标情况(≥110°C), 智能调节电流输出或关闭, 可自动恢复		
	过载保护	负载电流≥102%, 关闭输出, 可自动恢复		
	短路保护	输出线路短路进入打嗝模式, 可自动恢复		
	过压保护	空载电压≥28V, 关闭输出, 可自动恢复	空载电压≥16V, 关闭输出, 可自动恢复	
	耐压	输入对输出: 3750Vac		
安规和电磁规格	绝缘阻抗	输入对输出: 100MΩ/500VDC/25°C/70%RH		
	安全规范	CCC	中国	GB19510.1, GB19510.14
		TUV	德国	EN61347-1, EN61347-2-13, EN62493
		CB	CB成员国	IEC61347-1, IEC61347-2-13
		CE	欧盟	EN61347-1, EN61347-2-13, EN62384
		KC	韩国	KC61347-1, KC61347-2-13
		EAC	俄罗斯	IEC61347-1, IEC61347-2-13
		RCM	澳洲	AS 61347-1, AS 61347-2-13
		ENEC	欧洲	EN61347-1, EN61347-2-13, EN62384
	UKCA	英国	BS EN 61347-2-13:2014+A1:2017, BS EN 61347-1:2015+A1:2021	
	电磁兼容发射	CCC	中国	GB/T17743, GB17625.1
		CE	欧盟	EN55015, EN61000-3-2, EN61000-3-3, EN61547
		KC	韩国	KN15, KN61547
		EAC	俄罗斯	IEC62493, IEC61547, EH55015
		RCM	澳洲	EN55015, EN61000-3-2, EN61000-3-3, EN61547
UKCA		英国	BS EN IEC 55015:2019/A11:2020, BS EN 61547:2009, BS EN IEC 61000-3-2:2019, BS EN 61000-3-3:2013/A1:2019	
电磁兼容抗扰度		EN61000-4-2,3,4,5,6,8,11, EN61547		
频闪测试标准	IEEE 1789			
其他	产品重量	430g±10g		
	产品尺寸	352×43×30mm(L×W×H)		
	包装尺寸	355×44×33mm(L×W×H)		
	外箱规格	370×340×93mm(L×W×H) 20个/箱 9.4kg±5%/箱		

本款驱动器适合连接电阻限流的LED灯具(如LED灯条)。如果连接内置恒流IC限流的灯具, 会产生几十倍的瞬间浪涌电流, 导致驱动器会执行过载保护(打嗝频闪)。下单时这类内置恒流IC限流的灯具需要注明(如MR16灯杯、地理灯、洗墙灯、恒流硬灯条等), 以便烧写特殊程序。

保护盖应用图

压线板

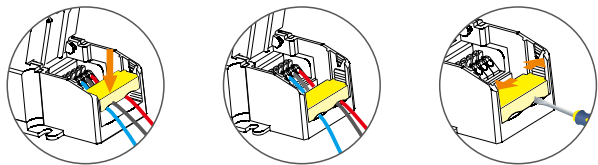

向下推压线板，可固定住线。

向外推侧板的同时，用工具撬即可拆下压线板。

保护盖的拆装

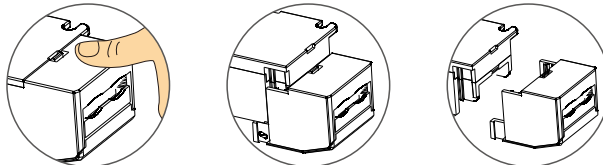

在底部左右掰动，即可将保护盖拆下。

安装注意事项

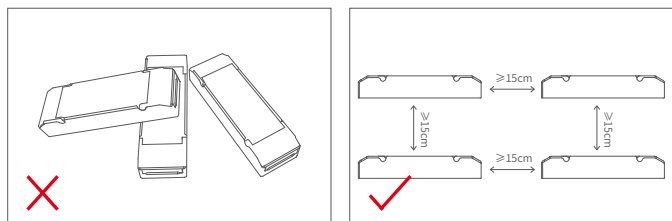

请勿将产品堆叠摆放，产品与产品间隔距离应 $\geq 15\text{cm}$ ，避免影响产品散热和使用寿命。

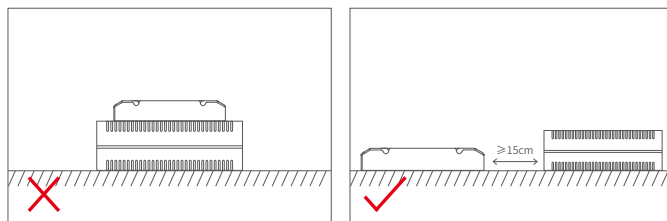

请勿将产品置于电源上方，与电源间隔距离应 $\geq 15\text{cm}$ ，避免影响产品散热而减少使用寿命。

DMX地址设置

DMX电源可以与遵从标准RDM协议的地址编辑器配合使用。

建议使用LTECH的RDM编辑器（型号WiFi-RDM01），可实现手机远程浏览与设置参数等更多功能，连接图如下：

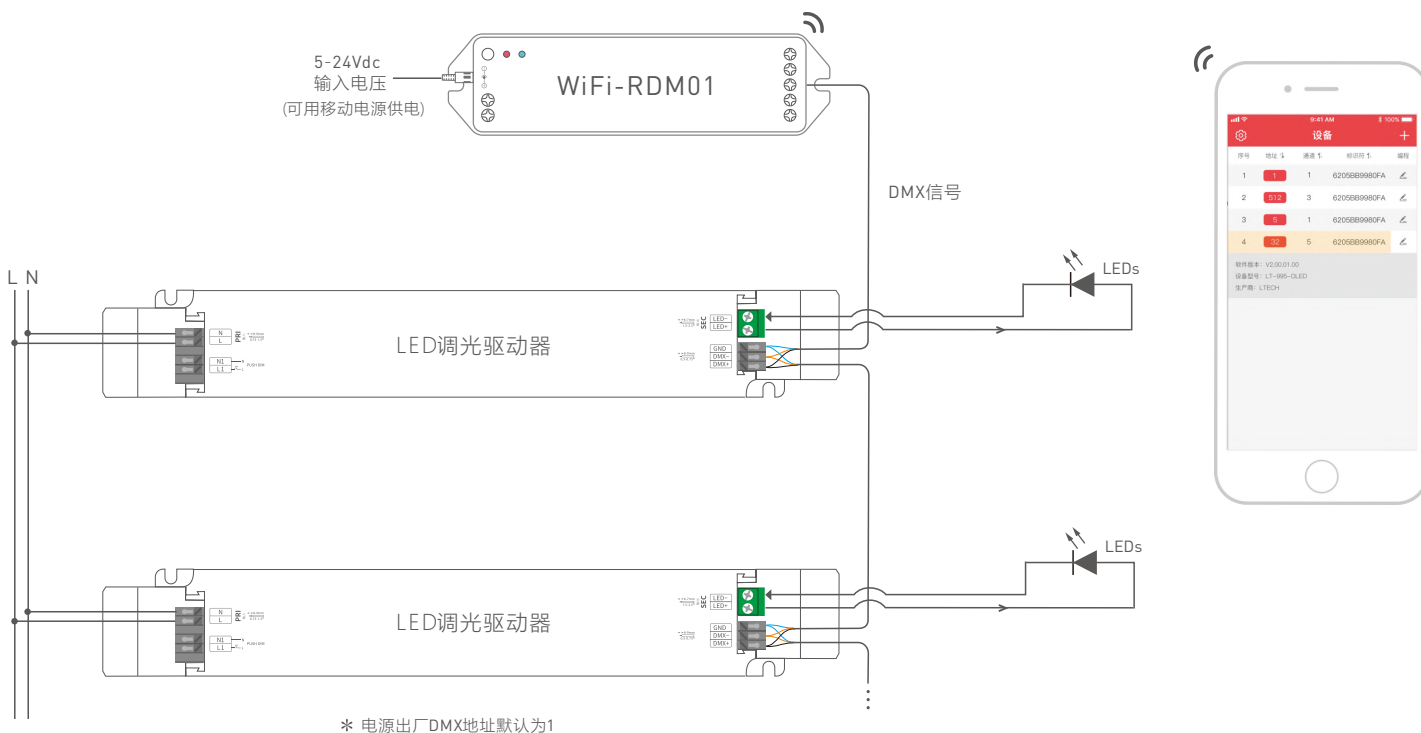

LTECH RDM编程器APP界面介绍

手机下载APP，与RDM编辑器连接成功后，即可通过APP设置参数，具体请参看WiFi-RDM01的使用说明书。

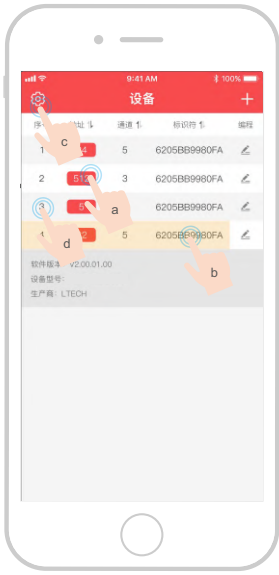

- a: 点击“地址”对应方可编辑地址;
- b: 点击“标识符”出现产品详细信息;
- c: 点击 按钮，进入设置界面
- d: 点击序号发出识别命令。

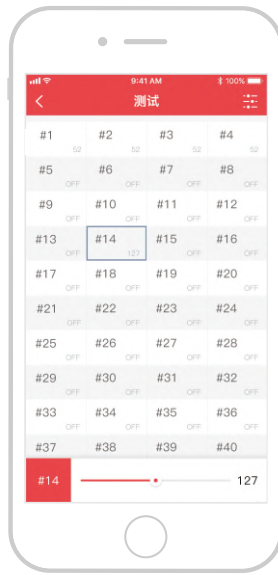

测试

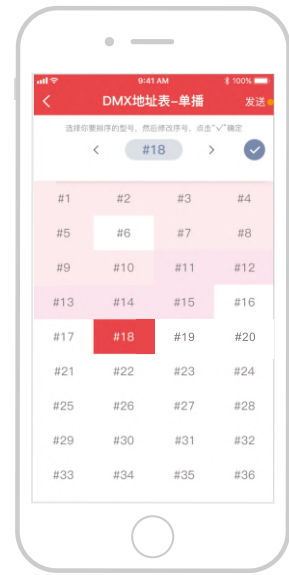

DMX地址设置

关系图表

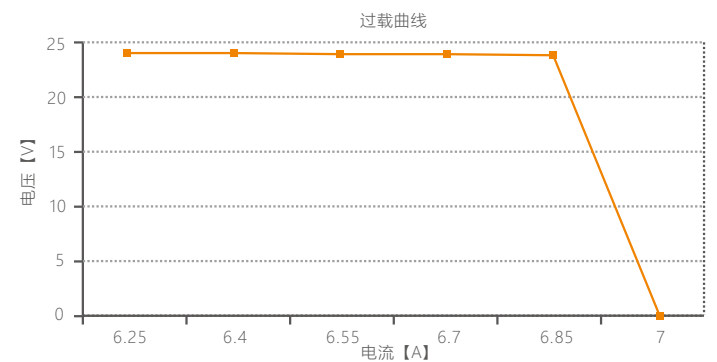
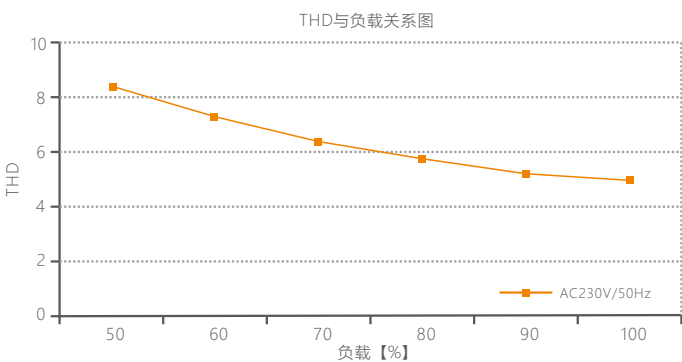
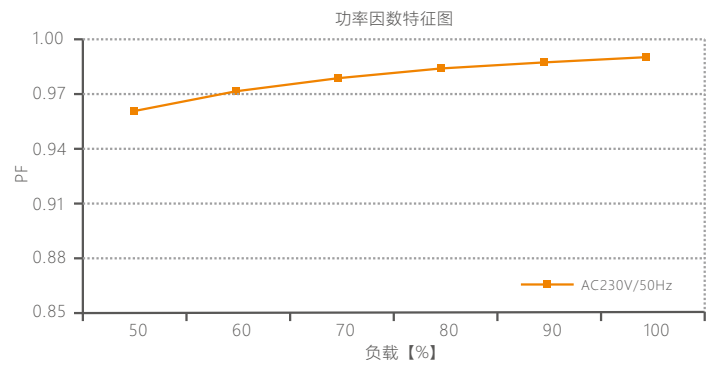
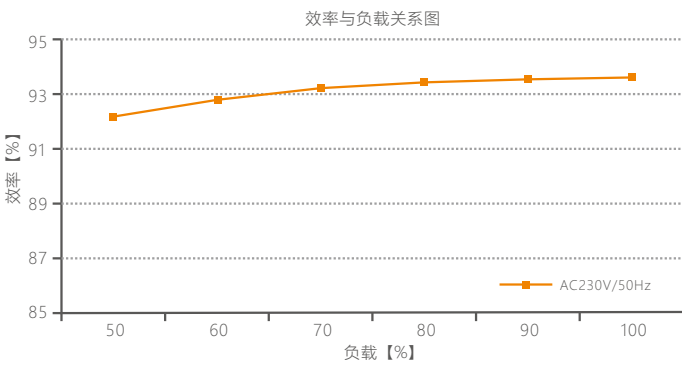

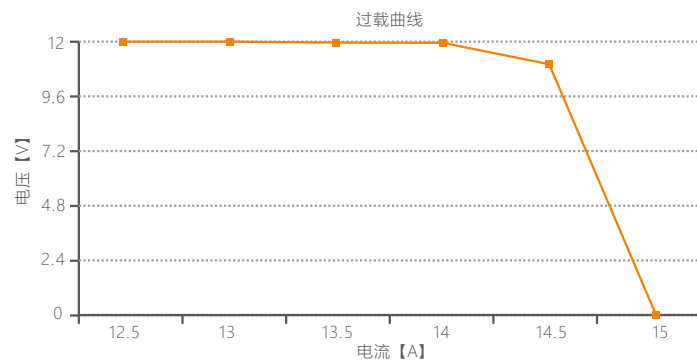
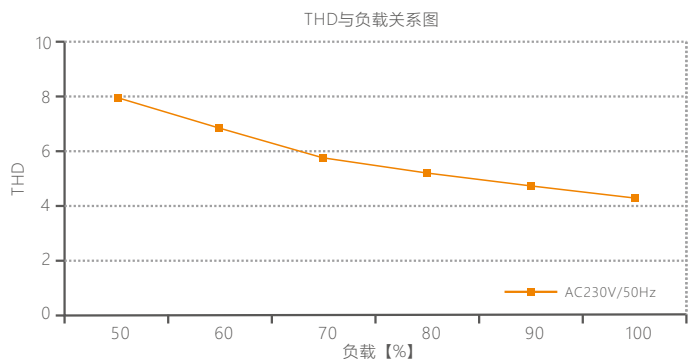
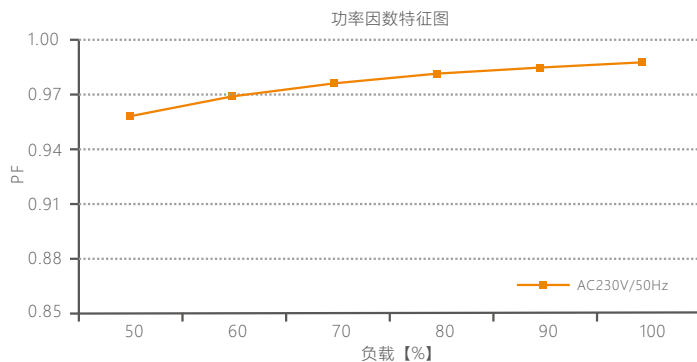
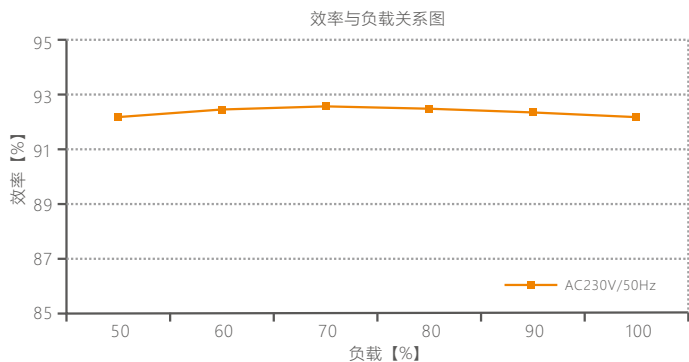

LM-150-12-G1M2

频闪测试表

IEEE 1789

低风险区域 (Low Risk) 的波动深度 (Modulation) 限值	
光输出波形频率 f	限值 (%)
$f < 8\text{Hz}$	0.2
$8\text{Hz} < f < 90\text{Hz}$	$0.025 \times f$
$90\text{Hz} < f < 1250\text{Hz}$	$0.08 \times f$
$f > 1250\text{Hz}$	免除考核
无风险区域 (No Effect) 的波动深度 (Modulation) 限值	
光输出波形频率 f	限值 (%)
$f < 10\text{Hz}$	0.1
$10\text{Hz} < f < 90\text{Hz}$	$0.01 \times f$
$90\text{Hz} < f < 3125\text{Hz}$	$[0.08/2.5] \times f$
$f > 3125\text{Hz}$	免除考核 (高频豁免)

亮度

- ▲ 0.1%
- ▲ 1%
- ▲ 5%
- ▲ 10%
- 20%
- ▲ 30%
- 40%
- ★ 50%
- 60%
- 70%
- 80%
- ★ 90%
- ◆ 100%

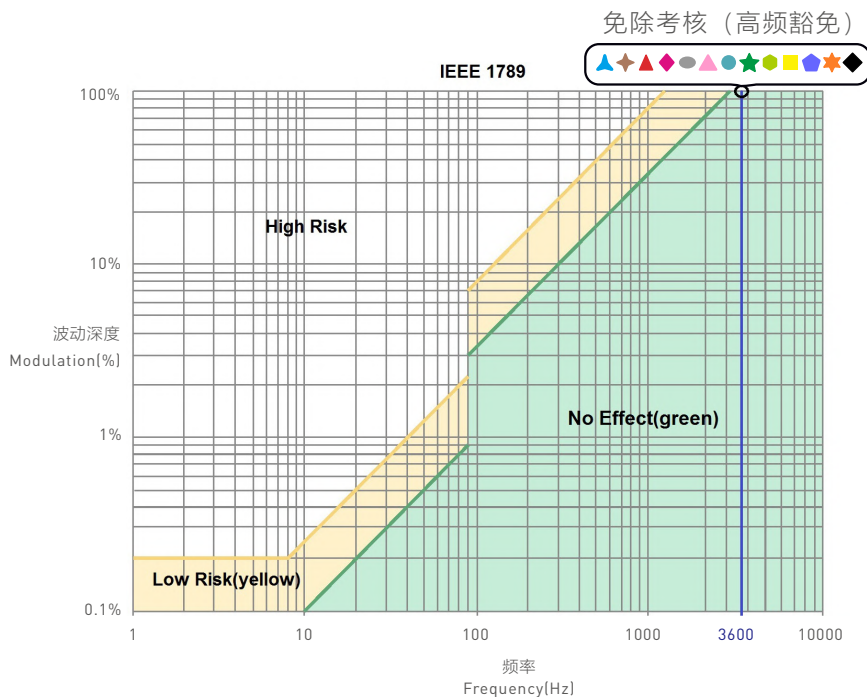

注意事项

- 请由具有专业资格的人员进行调试安装;
 - 雷特产品(专有型号除外)不能防水,需避免日晒雨淋,如安装在户外,请用防水箱;
 - 良好的散热条件会延长产品的使用寿命,请把产品安装在通风良好的环境;
 - 请检查使用的工作电压是否符合产品的参数要求;
 - 使用的电线直径大小必须能够负载连接的LED灯具,并确保接线牢固;
 - 通电调试前,应确保所有接线正确,避免因接线错误而导致灯具损坏;
 - 如果发生故障,请勿私自维修,如有疑问,请联系供应商。
- * 本说明书的内容如有变更,恕不另行通知。若内容与您使用的功能有所不同,则以实物为准。如有疑问,欢迎向我司授权的经销商咨询。

保修条例

- 自出厂之日起保修服务期为5年。
- 在保修服务期内出现产品质量问题雷特将给予免费修理或更换服务。

非保修条例:

属下列情况不在免费保修或更换服务范围之内:

- 已经超出保修服务期;
- 过高电压、超负载、操作不当等人为造成的损坏;
- 产品外形严重损坏或变形;
- 自然灾害以及人力不可抗拒原因造成的损坏;
- 产品保修标签和产品唯一条形码损坏;
- 无雷特签订的合同或发票凭证。

1. 修理或更换是雷特对客户的一补救措施。雷特不承担任何附带引起的损害赔偿,除非在适用法律范围之内。
2. 雷特享有修正或调整本保修条款的权利,并以书面形式发布为准。

更新日志

版本	更改日期	更改内容	更改人
A0	2020.03.24	正稿	黄韵婷
A1	2020.05.13	更新关系图表; 增加50000小时额定寿命	黄韵婷
A2	2021.12.10	更新产品描述; 更新TUV认证图标	刘伟丽