

PX24500D

Dmx Constant Voltage Decoder

Summary

Welcome to use the px series dmx 512 decode drive. Px series adopts advanced micro computer-controlled technology to digitalize dmx-512/1990 standard he control signal is converted into an analog control signal. Select 1 - 4 output channels per channel implements level 256 control level. Can be used for computer digital output dimming table and analog ilicon box connection, construction and lighting for led lighting control of he use of the occasion.



Product Characteristics

- ◆ Compliance with DMX 512/1990
- ◆ There are 4 channel outputs and Max. 5 A/CH output
- ◆ Decoder can diagnose and indicate DMX512 signal status (unconnected, suspended, normal), easy to use
- ◆ The DMX address can be set more easily by key.
- ◆ light color selected mechanism and can control the light with 1-4 colors.
- ◆ Class 256 brightness, full color control, control system, can express perfect effect
- ◆ Using logarithmic dimming curve to smooth the dimming effect
- ◆ To facilitate customer setup and use, the default address code is 1

Dimension(mm)

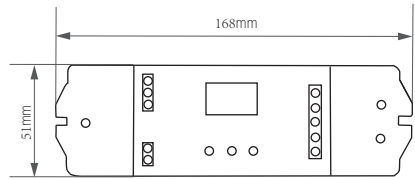

Technical Parameter

Decoding channel:	4ch
Input signal:	dmx-512/1990 standard digital control signal
Output signal:	0-24v max 5a isolated drive output
Power supply:	dc power supply, 12-24v
No-load consumption :	<1w
Power output :	<480w(24v); <240w(12v)
Working temperature :	20-50 C
equipment dimensions :	168(mm)*51(mm)*22(mm)
packing measurement:	171mm)*54(mm)*25(mm)
net weight :	160g
Gross weight :	180g

- (1) DMX Signal Input Interface
- (2) Power Input Interface
- (3) Display LED
- (4) Keys for address settings
- (5) Driver output interface

Interface Description

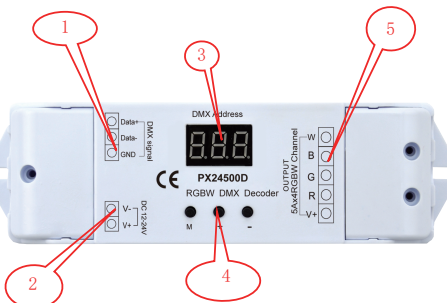

Interface Specification

● DMX signal interface

Note that the DMX signal polarity cannot be reversed, the DMX signal status display information as follows:

- 1, When the DMX signal line is not properly connected, the current address and - will be shown in a circular interval of 2 S;
- 2, When the DMX signal is paused, the current address and P will be displayed in a loop at intervals of 2S
- 3, When the DMX signal is normal, only the current address will be displayed

● Input Power Interface

DC 12/24V input to power the decoder itself and the lamps brought by the decoder

● Address code setting button

The address code can be automatically stored, and the last storage address code can be automatically restored after the next power on.

1, key M, used to unlock or lock the address code, when normal use, the address code cannot be changed. The comma at the bottom right of the LED digital tube after long pressing this button 3S will be lit up to indicate the unlock status, at this time the address can be changed, after changing the address, after long pressing M key 2S or after not pressing any key 5S, the digital tube comma will disappear, indicating that the address code is locked and cannot be modified.

2, the button, for the address add, short press the address each time add up 1, long press the address code to flip quickly, shorten the setting time, the maximum address 511

3, the key -, for the address reduction, short by the address of each decline 1, long by the address code to quickly flip, shorten the setting time, the minimum address 0 Note: factory address code is set to 1 by default

● Drive output interface

Common positive drive, with a V interface and 4-channel R, G, B, W output interface, can be connected to a variety of full color module and monochromatic module, automatically adjust the output current according to the lamp module load.

Note:

The main line and the R, G, B and W control lines can be directly connected to the corresponding pin of the output interface of the decoder. The monochrome module can connect the main line to the V-pin of the output interface of the decoder, and the negative line to the output interface R, G, B and W of the decoder according to the color of the module.

system connection

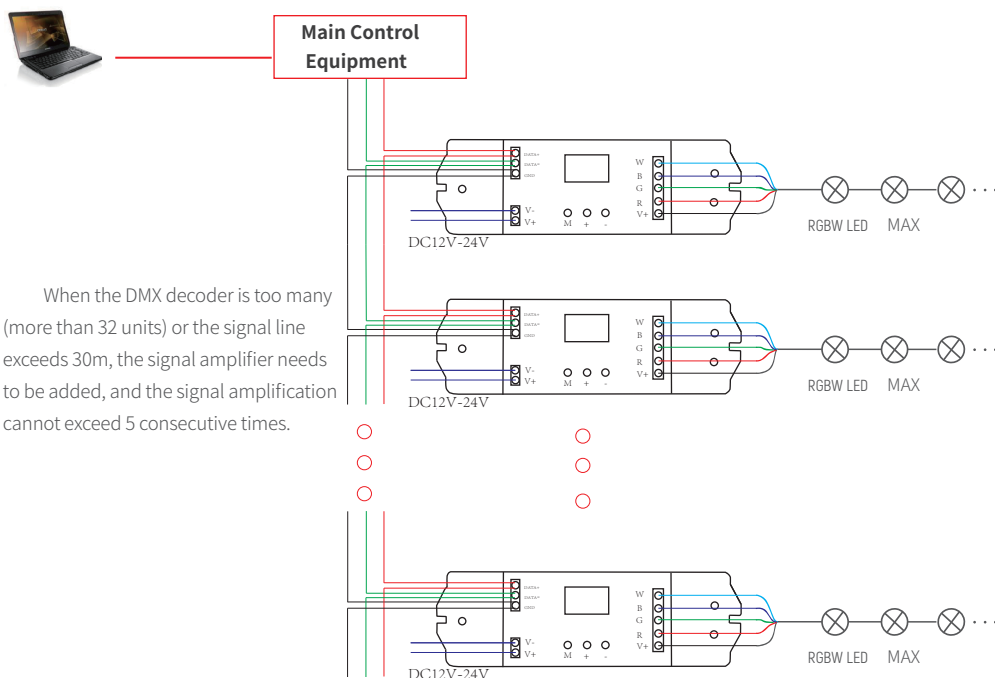

PX24500D

DMX恒压解码器

概述

欢迎使用PX系列 DMX512解码驱动器。PX系列采用先进的微电脑控制技术,把国际上广泛采用的DMX-512/1990 标准数码控制信号转换成模拟控制信号。可选择1~4 路输出通道,每通道可实现256级控制级别。可用于电脑数码输出调光台与模拟硅箱的连接,建筑和灯饰用LED灯具的控制的使用场合。

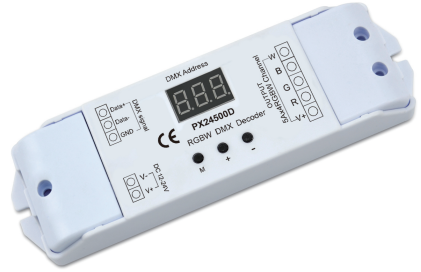

产品特点

- ◆符合DMX512/1990
- ◆有4个通道输出和Max.5A/CH输出
- ◆解码器可以诊断和指示DMX512信号状态(未连接, 暂停, 正常), 易于使用
- ◆可以通过键更容易地设置DMX地址。
- ◆采用浅色选定的机构, 并能用1~4种颜色控制光线。
- ◆256级亮度, 全彩色控制, 有控制系统, 能表达完美效果
- ◆利用对数调光曲线, 平滑调光效果
- ◆为方便客户设置和使用, 默认地址代码为1



技术参数

解码通道: 4路
 输入信号: DMX-512/1990 标准数码控制信号
 输出信号: 0~24V 最大5安培隔离驱动输出
 供电电源: 直流电源, 12~24V
 空载消耗: <1W
 功率输出: <480W(24V);<240W(12V)
 工作温度: -20~50°C
 设备尺寸: 168(mm)*51(mm)*22(mm)
 包装尺寸: 171mm)*54(mm)*25(mm)
 净重量: 160g
 毛重量: 180g

产品尺寸(mm)

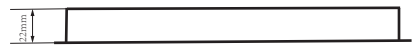
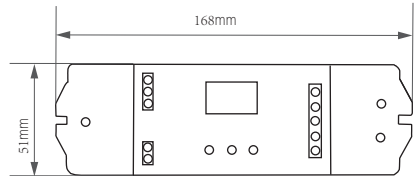

- (1) DMX信号输入接口
- (2) 电源输入接口
- (3) 显示LED
- (4) 地址设置的键
- (5) 驱动程序输出接口

接口说明

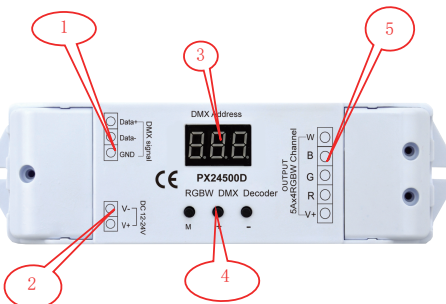

接口说明

●DMX 信号接口

请注意 DMX 信号极性, 不能反接, DMX 信号状态显示信息如下:

- 1, DMX 信号线没有正确连接时, 当前地址与 --- 将会循环显示, 间隔 2S;
- 2, DMX 信号暂停时, 当前地址与 P 将会循环显示, 间隔 2S
- 3, DMX 信号正常时, 将会显示当前地址

●输入电源接口

直流 12~24V 输入, 为解码器本身和解码器所带灯具供电

●地址码设置按键

地址码可以自动存储,下次上电后,自动恢复上次存储地址码

1, 按键 M, 用于解锁或锁住地址码, 正常使用时, 地址码无法更改。长按此按键 3S 后 LED 数码管右下方的逗号将会亮起, 用于指示解锁状态, 此时可以更改地址, 更改地址后, 长按 M 键 2S 后或不按任何按键 5S 后, 数码管逗号消失, 表明地址码加锁, 不可修改。

2, 按键+, 用于地址加, 短按地址每次累加 1, 长按地址码快速翻动, 缩短设置时间, 最大地址 511

3, 按键-, 用于地址减, 短按地址每次递减 1, 长按地址码快速翻动, 缩短设置时间, 最小地址 0注: 出厂时地址码默认为 1

●驱动输出接口

共阳驱动, 具有一个 V+ 接口和 4 通道 R,G,B,W 输出接口, 可接各种全彩模组和单色模组, 自动根据灯具模组负载调整输出电流。
注:

共阳连接的全彩模组可直接将正线和 R,G,B,W 控制线接至解码器的输出接口对应脚位上; 单色模组可将正线接至解码器的输出接口的 V+ 脚上, 负线根据该模块的颜色接至解码器的输出接口 R,G,B,W 某一脚位上; 几种颜色的单色模组接到同一个解码器上, 须将它们的正线都接到解码器的输出接口的 V+ 端口。

接线示意图

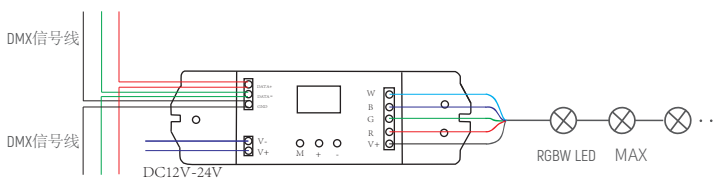

系统连接

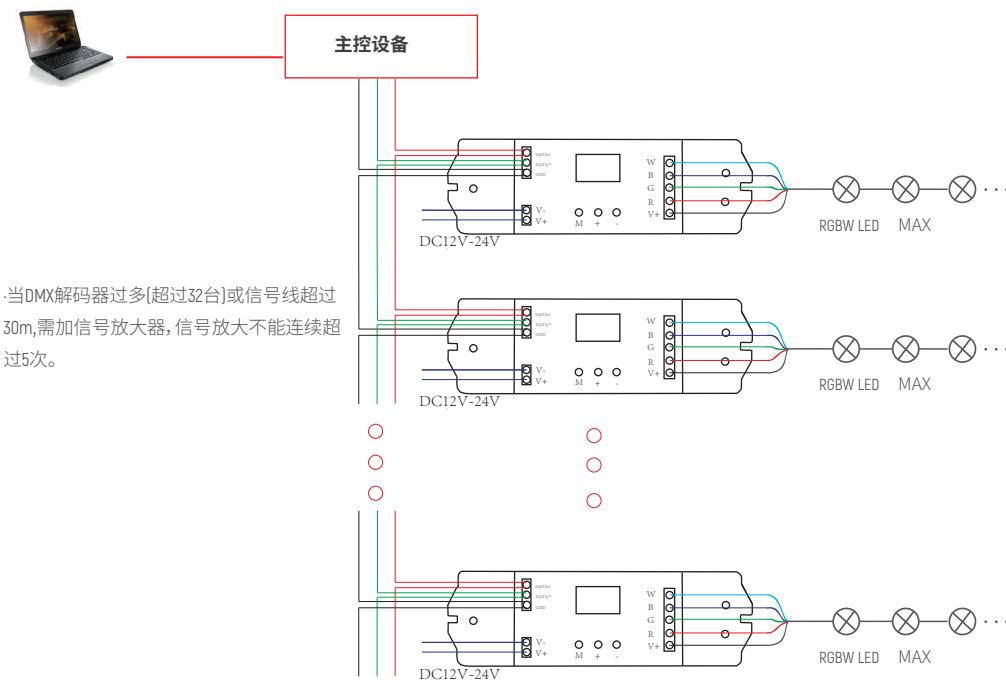

当DMX解码器过多(超过32台)或信号线超过30m,需加信号放大器,信号放大不能连续超过5次。