

## EUP40A-1H24V-1 (Product No.:103200130101)

### Summary

EUP40A-1H24V-1 is a constant voltage mode output LED driver. This driver can be controlled by external signal (0/1-10V active signal, adjustable resistance and PWM signal) to achieve a smooth dimming effect.

### Product Features

- Single channel constant voltage output,1.7A Max
- Support 3-in-1 dimming mode(0/1-10V active signal, adjustable resistance, PWM)
- Built-in active PFC function
- Dimming range of 0-100%, and dimming effect smooth, no flicker
- 100% output when no dimming signal input, can be used as normal power supply
- Over load protection; Over temperature protection; Short circuit protection
- Suitable for indoor LED lighting application, such as LED strips, spot light, wall washer,and so on



### Application

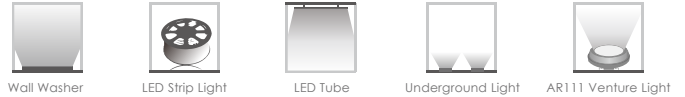

### Technical Parameters

Model	EUP40A-1H24V-1	
Input	Efficiency	>88%@230VAC,Full load
	Voltage	220VAC-240VAC
	Frequency Range(Hz)	50/60Hz
	Power Factor	≥0.95@230VAC,Full load
	THD(full load)	<10%@230VAC, Full load
	AC Current(max)	0.23Amax@230VAC
	Inrush Current(max)	Cold start,30A(twidth=650us measured at 50% Ipeak) @230VAC
Output	Current / Voltage / Power	1.7A/24VDC/40.8W
	R & N (Max)	400mVp-p
	Channel	1
	Voltage Accuracy	±3%
	Turn on delay Time	<1.5s, at230Vac
Function	Dimming Type	0/1-10V active signal, adjustable resistance, PWM
	Dimming Range	1%-100% Dimming to off
Protection	Short Circuit	Close output , recovers automatically after fault removed
	Over Load	Close output , recovers automatically after fault removed
	Over temperature	SClose the output, automatically restore the normal temperature
Others	Working Temp.	-20°C-50°C
	Storage Temp., Humidity	-40°C-85°C, 20-90%RH
	tc	90°C
	Material	PC
	IP Rating	IP20
	Lifetime	30,000h@tc:80°C
	Warranty Condition	3 years
	Switch Cycle	>15,000 times
	Packing(weight)	Net weight: 222g±5%/PCS; 50PCS/Carton;11.6kg±5%/Carton; Carton Size: 516*337*179mm(L*W*H)
Dimension	137*82*31mm (L*W*H)	

### Dimension(mm)

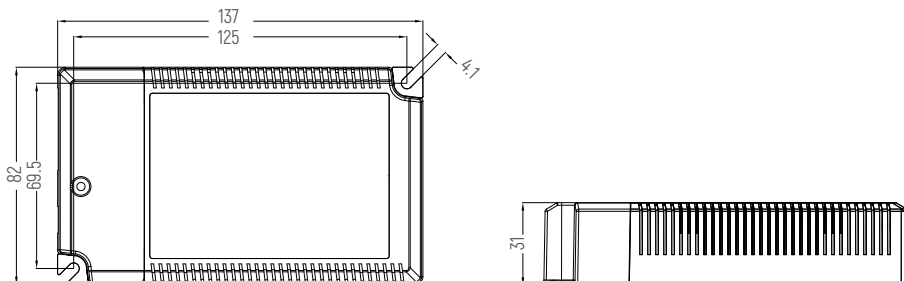

## 0/1-10V Wiring

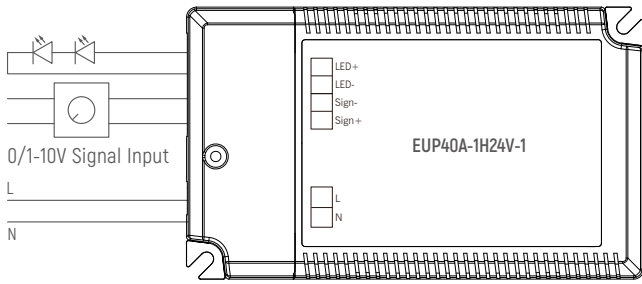

**Dimming Curve**

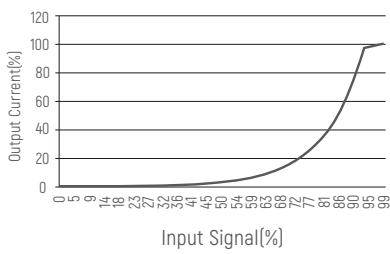

**Derating Curve**

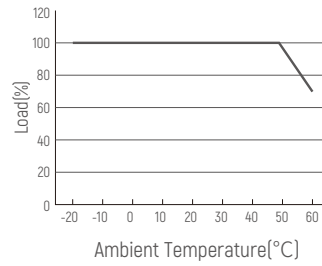

**PF vs Load**

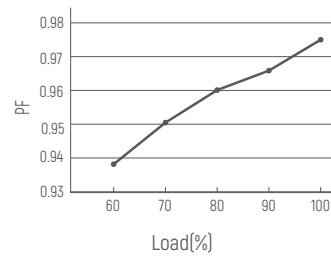

**THD vs Load**

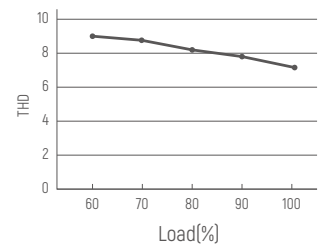

## Cautions

- 1.This product should be installed by qualified personnel.
- 2.This product is non waterproof, need to avoid sun and rain.In case of outdoor use, please ensure it is mounted in a water proof enclosure.
- 3.Good heat dissipation conditions extend product life. Please install the product in a well-ventilated environment.
- 4.Please make sure LED power supply output voltage, current is used to meet the product requirements.
- 5.Please ensure that adequate sized cable is used from the controller to the LED lights to carry the current. Please also ensure that the cable is secured tightly in the connector.
- 6.Due to safety concerns, PVC or rubber cord of 0.75- 1.5mm<sup>2</sup> is recommended for input and output terminal(s)(excluding signal terminals). Flat power cord is not suitable.Ensure all wire connections and polarities are correct before applying power to avoid any damages to the LED lights.
- 7.In case of malfunction, do not repair it yourself.

※ The contents of this manual are updated without prior notice. If the function of the product you are using is inconsistent with the instructions, the function of the product shall prevail.Please contact us if you have any questions .

## EUP40A-1H24V-1 (产品代码:103200130101)

### 概述

EUP40A-1H24V-1是一款可以用于室内的恒压输出LED调光驱动器。这款驱动器可以通过外部0/1-10V有源信号，可调电阻和PWM信号实现平滑调光的效果。当不接信号时，可作为常规电源使用。



### 产品特点

- 单通道恒压输出，最大输出电流为1.7A
- 支持3合1调光（0/1-10V有源信号，可调电阻，PWM信号）
- 内建主动式PFC功能
- 调光范围0-100%，调光曲线平滑，无闪烁
- 信号悬空时，满载输出，可作为常规电源使用
- 过温保护，短路保护，过流保护
- IP20，适用于室内LED灯具，比如LED灯带，投光灯，洗墙灯等

### 应用



### 技术参数

型号	EUP40A-1H24V-1	
输入	效率	>88%@230VAC, 满载
	电压	220VAC-240VAC
	频率	50/60Hz
	功率因素	≥0.95@230VAC, 满载
	THD	<10%@230VAC, 满载
	电流	0.23Amax@230VAC
	浪涌电流	冷启动30A(在50%Ipeak下测试 twidth =650 us)@ 230VAC
输出	电流/电压/功率	1.7A/24VDC/40.8W
	波纹	400mVp-p
	通道	1
	电压精度	±3%
	启动延时	<1.5s, at230Vac
功能	调光方式	0/1-10V有源信号，可调电阻，PWM信号
	调光范围	1%-100% 变暗直至关闭
保护	短路	关闭输出，排除故障后自恢复
	过温	关闭输出，自动恢复正常温度
	过流	当超过输出电压时，输出电流减小，当负载降低时自动恢复
其它	工作温度	-20°C~50°C
	储存温度、湿度	-40°C~85°C, 20-90%RH
	tc	90°C
	材质	PC
	防水等级	IP20
	寿命	30,000小时@tc:80°C
	质保	3年
	开关周期	>15,000次
	包装尺寸(重量)	净重: 220g±5%/PCS; 50PCS/ Carton; 11.6kg±5%/箱; 外箱尺寸: 516*337*179cm[长*宽*高]
	尺寸	137*82*31mm (长*宽*高)

### 尺寸(mm)

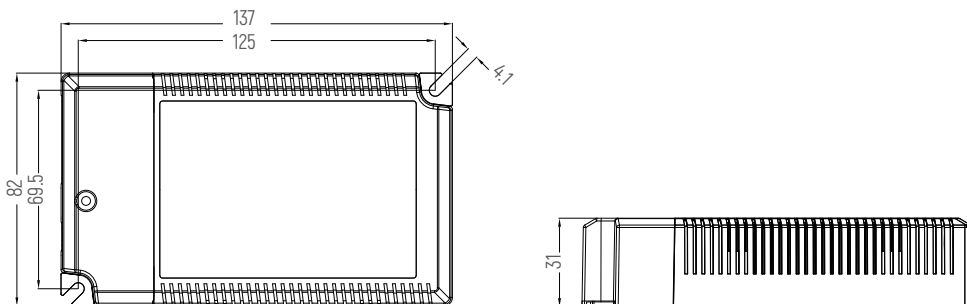

### 接线图

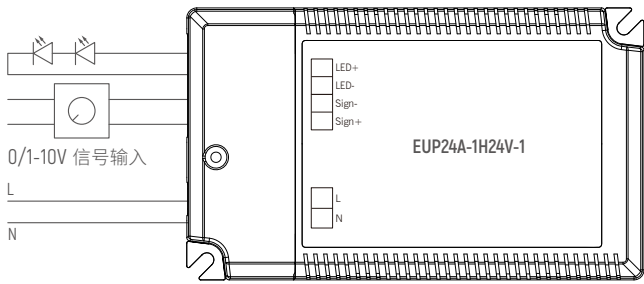

### 调光曲线

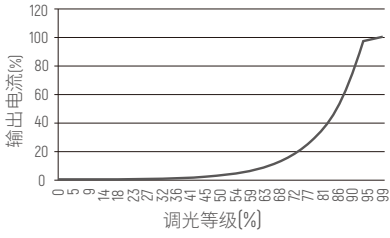

### 降额曲线

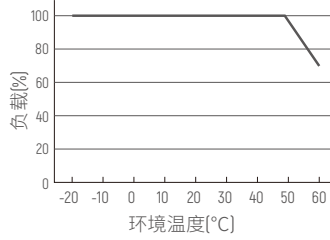

### PF vs 负载

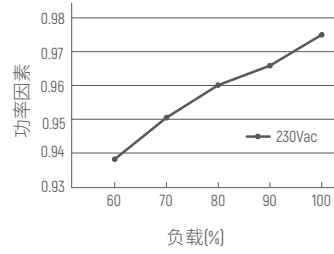

### THD vs 负载

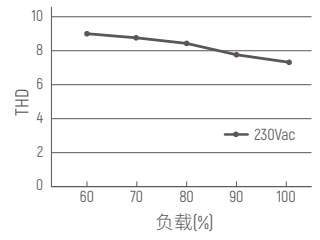

### 注意事项:

- 1、本产品请由具有专业资格的人员进行调试安装。
- 2、本产品不能防水，需避免日晒雨淋，如安装在户外，请用防水箱。
- 3、良好的散热条件会延长产品的使用寿命，请把产品安装在通风良好的环境。
- 4、请检查使用的LED电源输出电压电流，是否符合产品要求。
- 5、出于安全考虑，推荐输入和输出（信号端除外）用0.75-1.5mm<sup>2</sup> PVC或橡胶线缆，并确保接线牢固，以免电线过热或接触不良触发事故。扁平电源线不适用。
- 6、通电调试前，应确保所有接线正确，以避免因接线错误而导致灯具损坏。
- 7、如果发生故障，请勿私自维修；如有疑问，请联系供应商。

※ 本说明书内容如有更新，恕不另行通知。若您使用的产品功能与说明书不一致时，请以产品为准。如有疑问请与我们联系。